

COMSAT AT 10

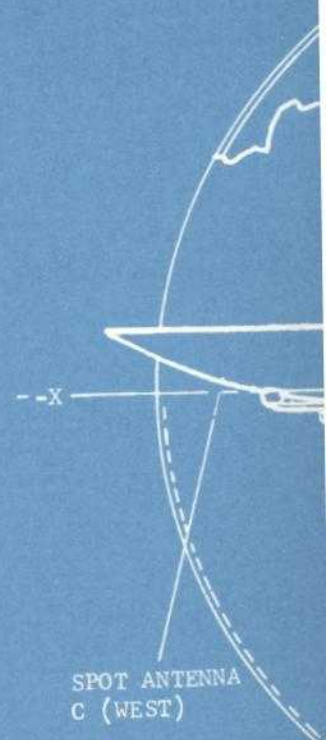

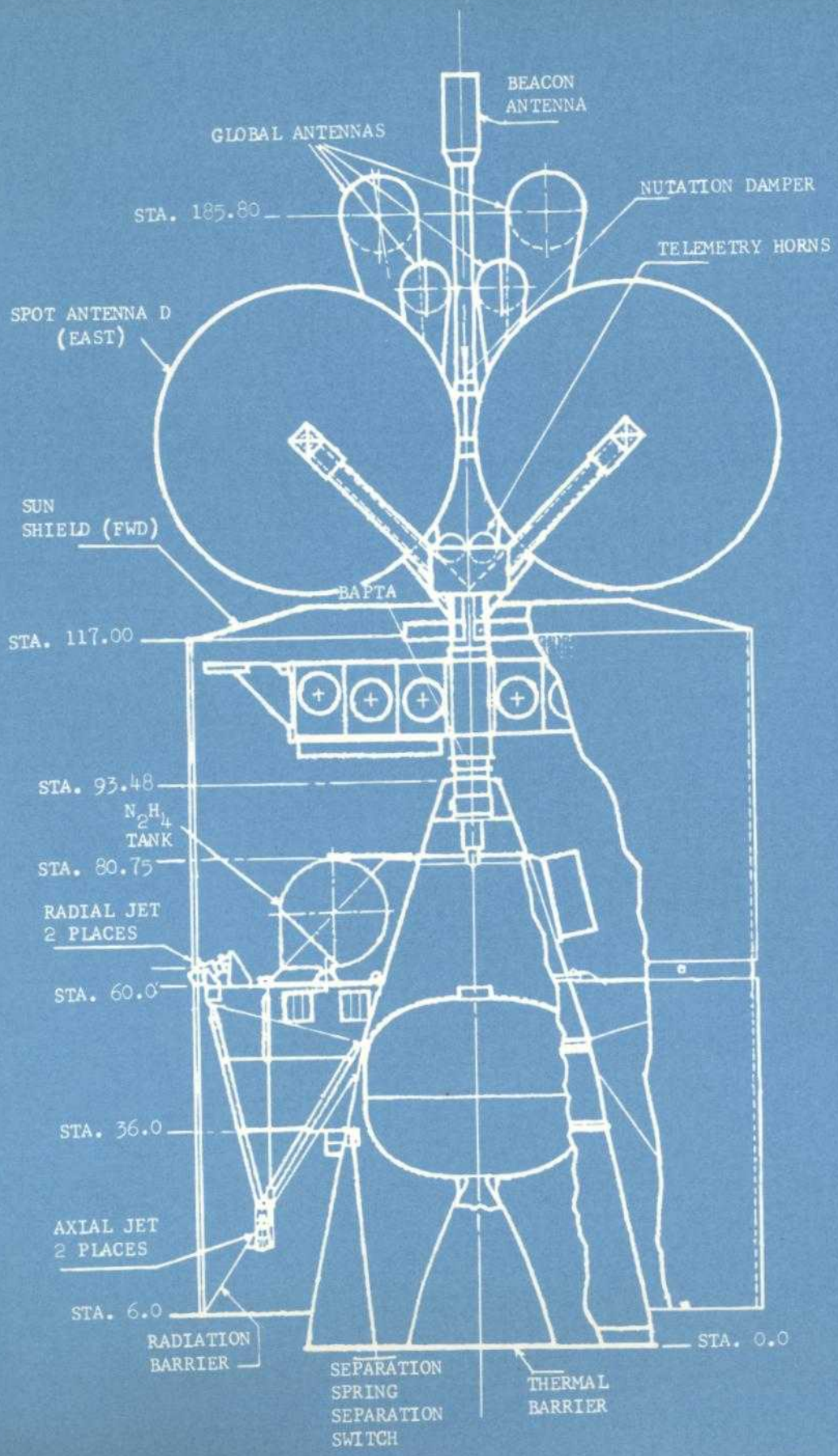

PRINCIPAL AXIS (DIRECTION OF ANGULAR ↑)

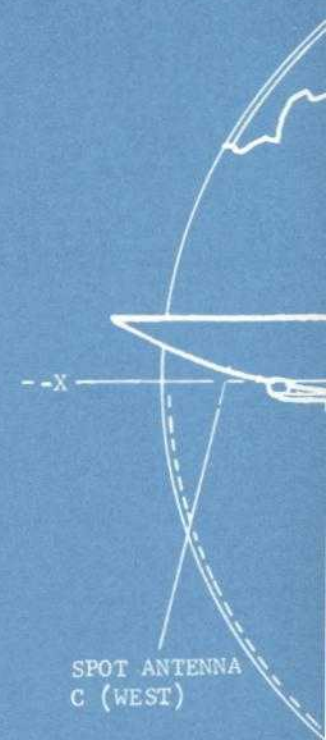
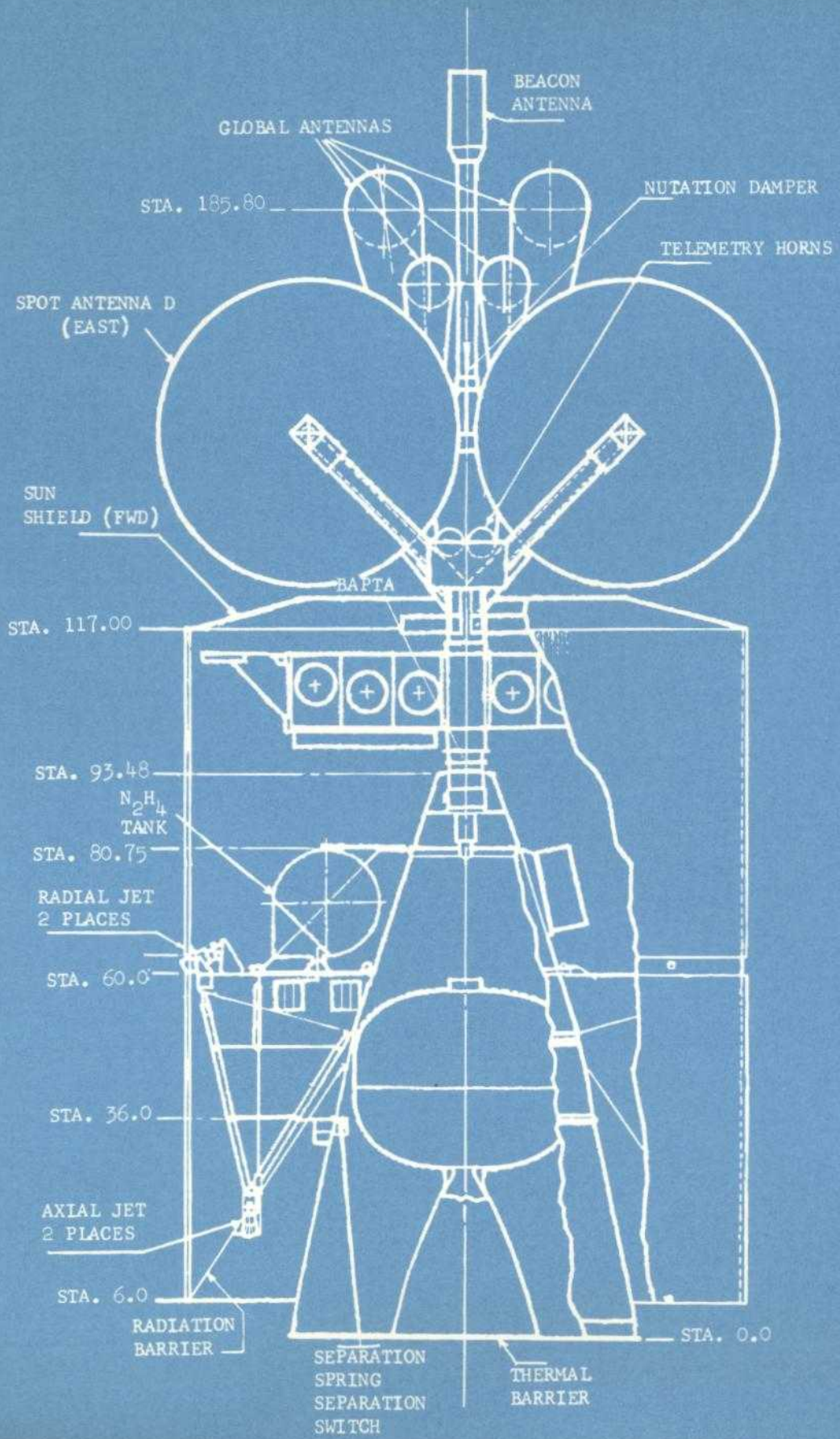

PRINCIPAL AXIS (DIRECTION OF ANGULAR ↑)

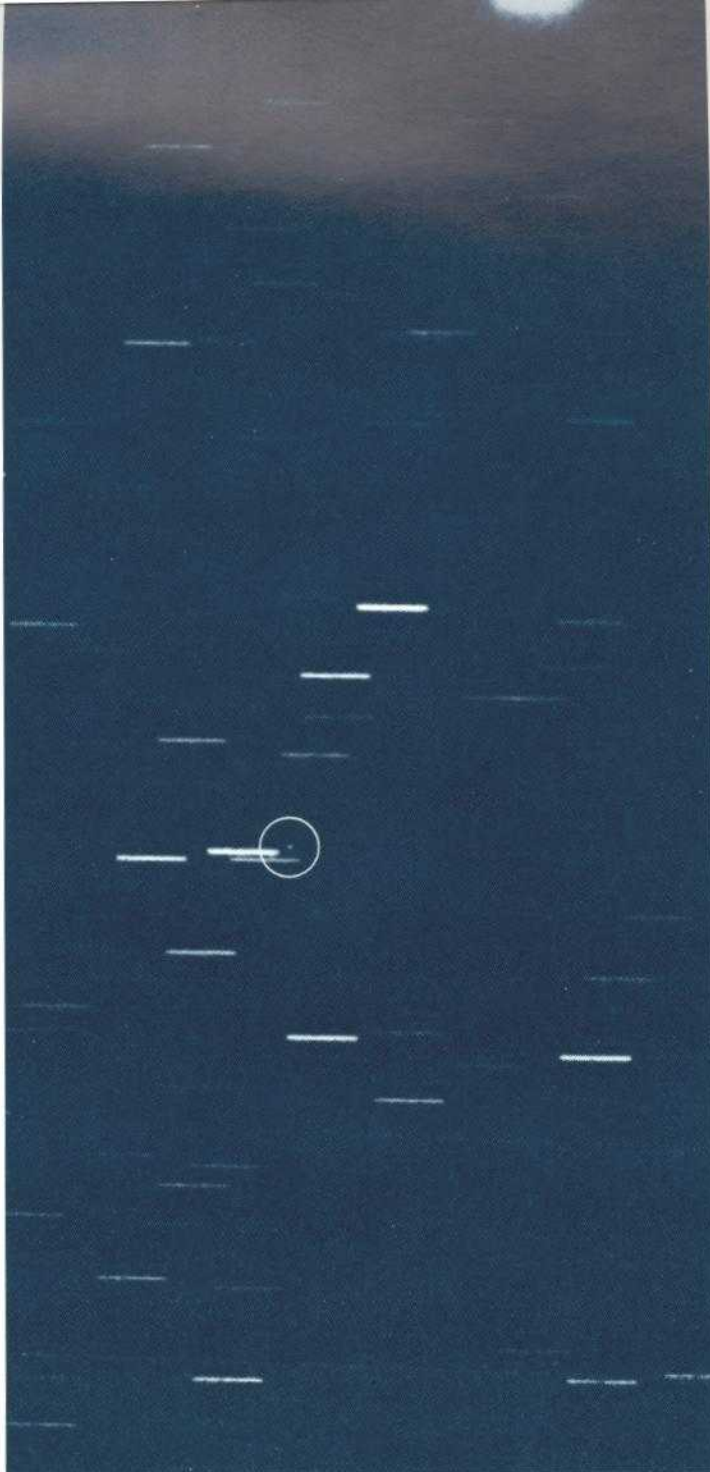

A satellite in synchronous orbit is nearly stationary with respect to the earth. This can be seen in the photograph of the INTELSAT III, F-6, over the Atlantic Ocean at the synchronous altitude of approximately 22,300 statute miles. The photograph was taken by Smithsonian Astrophysical Observatory staff members with a Baker-Nunn camera at the Natal, Brazil, satellite tracking station on the night of September 25-26, 1970. The exposure was 22 seconds, during which time the earth's rotation caused streaked star paths on the film. But the satellite, its orbital velocity synchronized with the earth's rotation, appears as a stationary dot near the end of one of the star trails.

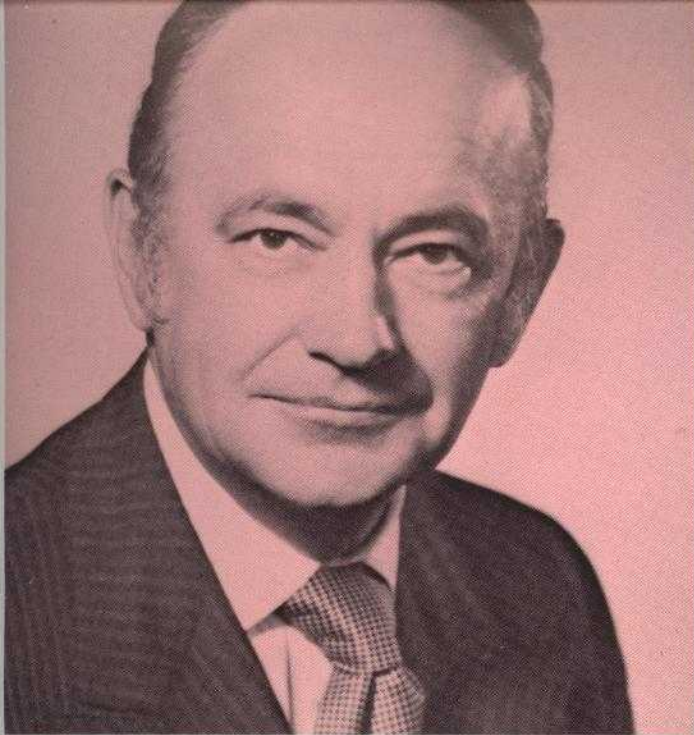

JOSEPH V. CHARYK

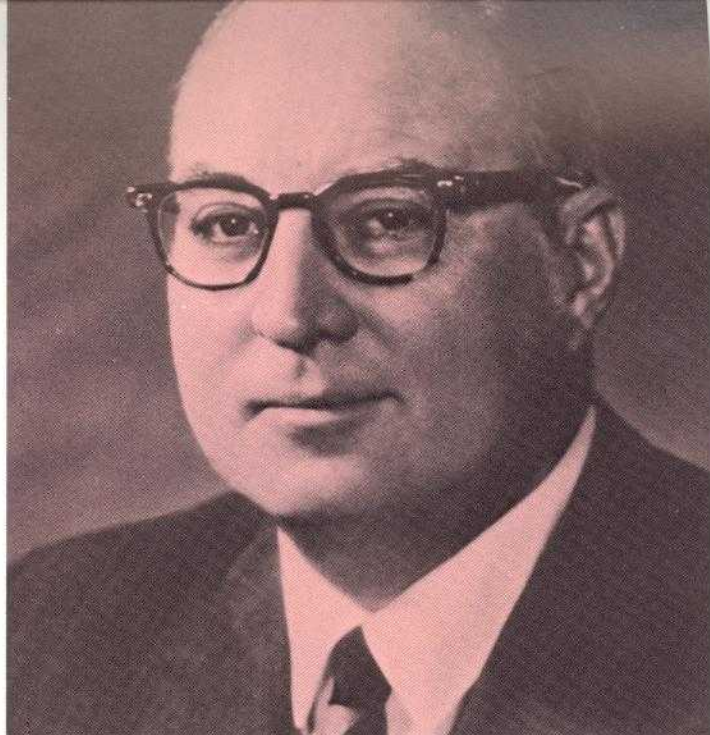

JOSEPH H. McCONNELL

At the tenth anniversary...

Ten years ago the Communications Satellite Corporation (COMSAT) had just been incorporated and had no staff, no money, and no facilities. Its chief, and virtually only, asset was a mandate from the Congress to establish, in conjunction and cooperation with other nations, a commercial communications satellite system as expeditiously as practicable. This asset was also an awesome responsibility.

This responsibility has been fulfilled with a degree of dispatch and success that few, if any, thought possible ten years ago. With COMSAT as Manager on behalf of all the international partners, the INTELSAT global satellite system is a successful reality. Operational satellites provide global coverage for a network of earth stations in 49 countries. The system now provides much of the world's trans-oceanic telephone and record communications, as well as dramatic capability for global television transmissions. The system has revolutionized the world's communications network.

COMSAT's second decade will bring continuing expansion and improvement of the global system.

In spite of difficulties along the way, the accomplishments have been impressive. Credit for this is shared by our shareholders, international partners, customers, employees, contractors, and those Government agencies who are charged with special duties in overseeing our affairs. A particular debt is owed to the Congress whose legislation became the foundation for COMSAT and the global system. Together we can take pride in COMSAT's progress thus far, and together we can look forward to greater progress in the second decade.

Handwritten signatures in blue ink. The signature on the left is 'Joseph V. Charyk' and the signature on the right is 'Joseph H. McConnell'.

JOSEPH V. CHARYK
President

JOSEPH H. McCONNELL
Chairman of the Board
of Directors



prelude	The Satellite Act is passed	2
	President Kennedy signs the Satellite Act	2
	Incorporators are nominated	2
1963	COMSAT is incorporated	4
	First headquarters	4
	First officers are elected	4
1964	Early Bird contract	6
	Stock issue is oversubscribed	6
	COMSAT listed on the stock exchanges	6
	INTELSAT is established	9
	First ICSC meeting	9
	First shareholders meeting	10
	COMSAT's first service	10
1965	Early Bird is launched	12
	COMSAT is awarded earth stations	12
	Early Bird cable restoration	14
	COMSAT's first tariff	14
	Early Bird commercial service	14
	INTELSAT II contract	16
	Ground is broken at Brewster	17
	Ground is broken at Paumalu	17
1966	INTELSAT III contract	18
	COMSAT's first domestic proposal	18
	First INTELSAT II launch	18
	First TT&C station enters service	18
	Three more U.S. earth stations	18
1967	Second INTELSAT II launch	20
	Third INTELSAT II launch	20
	Fourth INTELSAT II launch	20
	Tokyo service inaugurated	22
	COMSAT rates are reduced	22
	Full commercial operations	22
	Live TV from the White House to Italy	23
First net operating profit	23	
1968	First INTELSAT III launch	24
	Service begins at Jamesburg	24
	Second INTELSAT III launch	24
	INTELSAT IV contract	26
	Second standard antenna at Paumalu	26

1969	Cayey station is dedicated	28
	Service begins at Etam	28
	Further INTELSAT III launches	28
	Full global coverage	31
	First step on the moon	32
	International conference convenes	34
	New COMSAT Laboratories	34
1970	COMSAT aeronautical proposal	36
	World Cup soccer matches	36
	Bartlett enters service	36
	COMSAT proposes system for AT&T	38
	First COMSAT dividend	38
1971	First INTELSAT IV launch	40
	NICATELSAT is established	42
	Definitive agreements	42
	Second INTELSAT IV launch	42
1972	President Nixon in China	44
	Andover horn replaced	46
	Third INTELSAT IV launch	46
	Queen Elizabeth 2 tests	46
	President Nixon in Moscow	46
	Fourth INTELSAT IV launch	46
	The Satellite Act at 10	49
	The Munich Olympic games	49
	COMSAT rate case	49
	A new COMSAT domestic proposal	49
	54 nations approve definitive arrangements	49
	FCC approves COMSAT's two domestic proposals	49
	The Board of Directors	52
present	The global system at COMSAT's 10th anniversary	53

The ultimate result will be to encourage and facilitate world trade, education, entertainment and many kinds of professional, political and personal discourses which are essential to healthy human relationships and international understanding.

JOHN F. KENNEDY
August 1962

PRELUDE

August 27, 1962—Congress completed its passage of the Communications Satellite Act of 1962, which set forth a national policy for the establishment of a satellite system in cooperation with other nations. The Satellite Act authorized a new, private company to be formed to represent the United States in the satellite system. That company is COMSAT.

The responsibility of Congress did not end with passage of the Act; relevant committees of Congress have a continuing interest in how the objectives of the Act are implemented.

August 31, 1962—The Satellite Act became law when President John F. Kennedy signed it in a White House ceremony attended by sponsors and supporters of the legislation. The President of the United States and the Executive Department were given special responsibilities for overseeing the implementation of the national policy set forth in the Act, and the President was directed to report annually to Congress on activities and accomplishments under the Act.

October 4, 1962—The Incorporators of the Corporation were nominated by President Kennedy, and given recess appointments on October 15, 1962, with responsibility for directing the initial activities of the Corporation. The Incorporators became the first Board of Directors, serving until the shareholders elected a Board at the First Annual Meeting. Their nominations by President Kennedy were confirmed by the Senate.

world trade, education, entertainment and many kinds of professional, political and personal discourses which are essential to healthy human relationships and international understanding.

JOHN F. KENNEDY



Public Law 87-624
87th Congress, H. R. 11040
August 31, 1962

An Act

76 STAT. 419.

To provide for the establishment, ownership, operation, and regulation of a commercial communications satellite system, and for other purposes.

Be it enacted by the Senate and House of Representatives of the United States of America in Congress assembled,

TITLE I—SHORT TITLE, DECLARATION OF POLICY AND DEFINITIONS

SHORT TITLE

Sec. 101. This Act may be cited as the "Communications Satellite Act of 1962".

DECLARATION OF POLICY AND PURPOSE

Sec. 102. (a) The Congress hereby declares that it is the policy of the United States to establish, in conjunction and in cooperation with other countries, as expeditiously as practicable a commercial communications satellite system, as part of an improved global communications network, which will be responsive to public needs and national objectives, which will serve the communication needs of the United States and other countries, and which will contribute to world peace and understanding.

(b) The new and expanded telecommunication services are to be made available as promptly as possible and are to be extended to provide global coverage at the earliest practicable date. In effectuating this program, care and attention will be directed toward providing such services to economically less developed countries and areas as well as those more highly developed, toward efficient and economical use of the electromagnetic frequency spectrum, and toward the reflection of the benefits of this new technology in both quality of services and charges for such services.

(c) In order to facilitate this development and to provide for the widest possible participation by private enterprise, United States participation in the global system shall be in the form of a private corporation, subject to appropriate governmental regulation. It is the intent of Congress that all authorized users shall have nondiscriminatory access to the system; that maximum competition be maintained in the provision of equipment and services utilized by the system; that the corporation created under this Act be so organized and operated as to maintain and strengthen competition in the provision of communications services to the public; and that the activities of the corporation created under this Act and of the persons or companies participating in the ownership of the corporation shall be consistent with the Federal antitrust laws.

(d) It is not the intent of Congress by this Act to preclude the use of the communications satellite system for domestic communication services where consistent with the provisions of this Act nor to preclude the creation of additional communications satellite systems, if required to meet unique governmental needs or if otherwise required in the national interest.

Communications
Satellite Act
of 1962.

Those who served as Incorporators and their occupations at the time were Beardsley Graham, President, Spindletop Research, Inc., Lexington, Ky.; Philip L. Graham, President, The Washington Post, Washington, D.C.; John T. Connor, President, Merck & Co., Rahway, N.J.; George T. Feldman, Vice President and Counsel, Mastan Co., New York, N.Y.; Sam Harris, Attorney, New York, N.Y.; Edgar F. Kaiser, President, Kaiser Industries Corporation, Oakland, Calif.; David M. Kennedy, Chairman, Continental Illinois National Bank and Trust Company of Chicago, Ill.; George Killion, President, American President Lines, San Francisco, Calif.; Byrne Litschgi, Attorney, Tampa, Fla.; Leonard H. Marks, Attorney, Washington, D.C.; Bruce G. Sundlun, Attorney, Providence, R.I., and Washington, D.C.; Sidney J. Weinberg, Partner, Goldman, Sachs & Co., New York, N.Y.; and Leonard Woodcock, Vice President, UAW-CIO, Detroit, Mich. The Incorporators held their first meeting on October 22, 1962.

COMSAT, under the provisions of the Satellite Act and as a U. S. communications common carrier, is subject to regulation by the Federal Communications Commission. Thus, from the beginning the Commission has had a statutory role in the implementation of the national policy for satellite communications services.



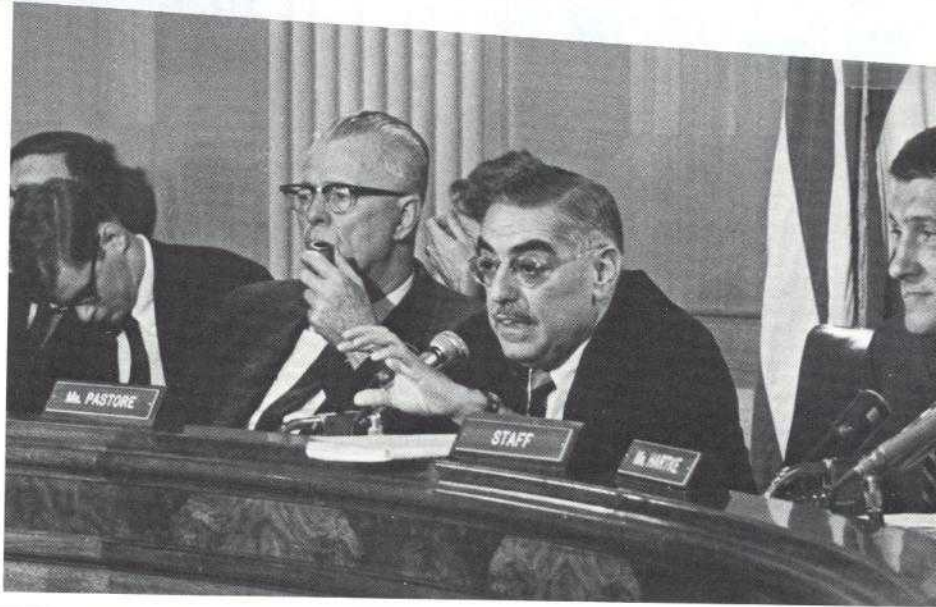
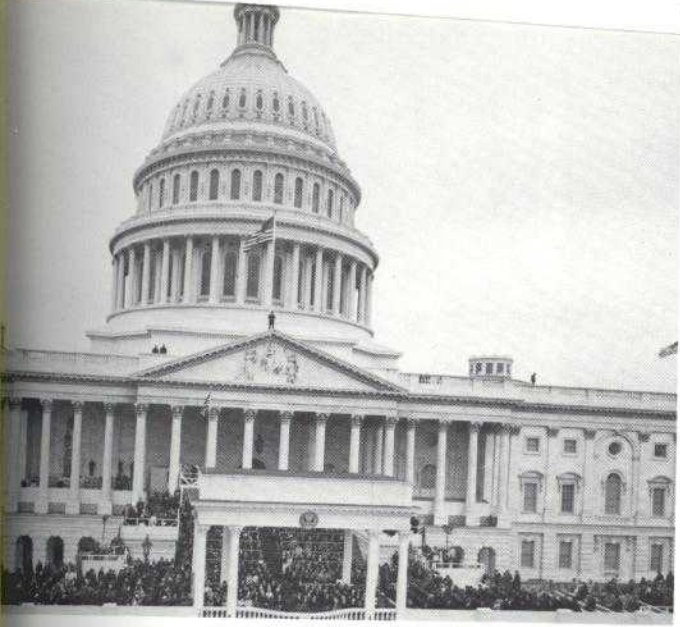

1963

DISTRICT OF COLUMBIA
OFFICE OF SUPERINTENDENT OF CORPORATIONS
CERTIFICATE OF INCORPORATION
OF
COMMUNICATIONS SATELLITE CORPORATION

680416

The undersigned, as Superintendent of Corporations of the District of Columbia, hereby certifies that duplicate originals of Articles of Incorporation for the incorporation of Communications Satellite Corporation, pursuant to the provisions of the Communications Satellite Act of 1962, duly signed and verified pursuant to the provisions of the District of Columbia Business Corporation Act of June 8, 1954, as amended, have been received in this office and are found to conform to law.

ACCORDINGLY, the undersigned, as such Superintendent of Corporations, and by virtue of the authority vested in him by law, hereby issues this Certificate of Incorporation of Communications Satellite Corporation and attaches hereto a duplicate original of the Articles of Incorporation.

Dated February 1st 1963



Alfred Galsterer
Superintendent of Corporations

FILED

BY: AKG

February 1, 1963—The Communications Satellite Corporation (COMSAT) was officially born with the issuance of its Certificate of Incorporation by the Superintendent of Corporations for the District of Columbia.

COMSAT's Articles of Incorporation were adopted on January 29, 1963, and transmitted to the President of the United States. President Kennedy approved them on January 31 and returned them to the Incorporators, along with an opinion by Attorney General Robert F. Kennedy, who advised that the Articles were not inconsistent with any provisions of the Communications Satellite Act.

Later in the month a \$5 million line of credit with commercial banks for COMSAT's start-up costs was approved by the FCC.

February 15, 1963—For its first headquarters, COMSAT leased Tregaron, a large Northwest Washington home formerly owned by Joseph E. Davies, U.S. Ambassador to Moscow during World War II.

COMSAT occupied Tregaron until November 1964 when it moved its headquarters to an office building at 1900 L Street, N.W., in downtown Washington. At the same time, COMSAT established its technical staff and its initial satellite control center in an office building at 2100 L Street, N.W.

In June 1968 the headquarters and technical staff were moved to the COMSAT Building at L'Enfant Plaza in Southwest Washington. The new building contains a permanent Spacecraft Technical Control Center, an Operations Center, and headquarters facilities for INTELSAT. Command and control of the satellites is exercised by the Spacecraft Technical Control Center. The Operations Center supervises and monitors traffic routings for the global satellite system.

March 10, 1963—The Board of Directors formally elected the two principal officers of the Corporation. The first Chairman and Chief Executive Officer of the Corporation was Leo D. Welch, a former Chairman of the Board of the Standard Oil Company (New Jersey). Dr. Joseph V. Charyk, the first President, earlier served as Under Secretary of the Air Force after wide experience in industry and on university faculties.

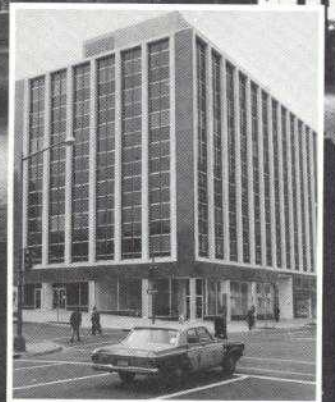

PHILIP L. GRAHAM

Chairman of the Incorporators 1962



SAM HARRIS

Chairman of the Incorporators 1962-1963



LEO D. WELCH

Chairman and Chief Executive Officer 1963-1965

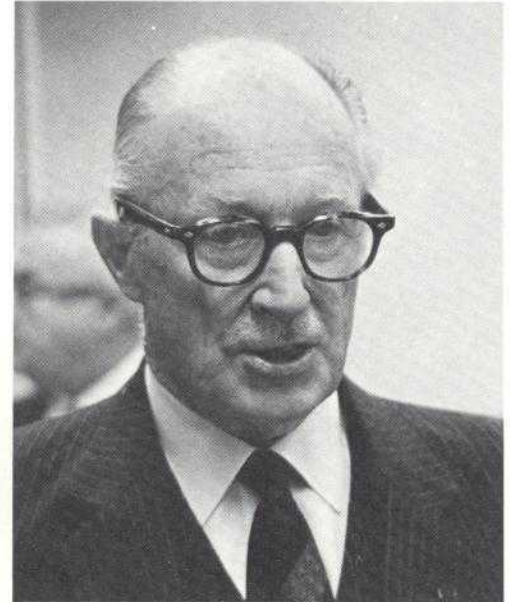

JOSEPH V. CHARYK
President 1963-



JAMES McCORMACK
Chairman and Chief Executive Officer 1965-1970



JOSEPH H. McCONNELL
Chairman of the Board 1970-

1964

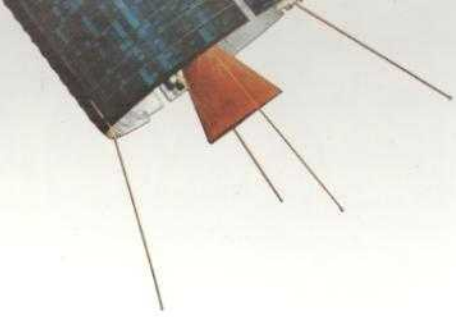

April 16, 1964—COMSAT awarded its first hardware contract, an order to Hughes Aircraft Company for an experimental-operational satellite to test the feasibility of synchronous orbits for commercial communications satellites. The contract also provided for a backup in case the first satellite should be a failure.

Later the satellite was named Early Bird and still later was designated as INTELSAT I. As events would prove, the Early Bird program was a resounding success.

June 2, 1964—COMSAT's initial stock issue was oversubscribed the first day. It consisted of 10 million shares at \$20 a share. Net proceeds to COMSAT were about \$196 million.

Under provisions of the Satellite Act, half of this stock (Series I) was sold to the public in a manner encouraging the widest possible distribution to the American public. A nationwide group of 385 underwriting firms offered the shares to the public. The result was over 130,000 individual shareholders of record.

The other half of the stock (Series II) was sold to 163 communications common carriers, which had been authorized by the Federal Communications Commission to hold shares. (At the end of 1972, about 60 carriers held approximately 30 percent of COMSAT's outstanding shares. These included American Telephone and Telegraph Company with about 2.9 million shares.)

September 8, 1964—COMSAT shares (ticker symbol: CQ) were listed on the New York, Midwest, and Pacific Coast Stock Exchanges.

On COMSAT's stock certificate is a prophetic vignette devised in early 1964. It shows a classical female figure against a background of the Earth turning in orbit and a communications satellite transmitting communications across an ocean. The certificates were designed and engraved by American Banknote Company, in accordance with New York Stock Exchange requirements for a human figure not easily counterfeitable and special paper with colored fibers and other security characteristics.



N56642

NOT VALID FOR LESS THAN 100 SHARES

THE TRANSFERABILITY OF THE SHARES REPRESENTED BY THIS CERTIFICATE IS RESTRICTED. SEE REVERSE SIDE.

NO. 00027



THE TRANSFERABILITY OF THE SHARES REPRESENTED BY THIS CERTIFICATE IS RESTRICTED. SEE REVERSE SIDE.

200

THIS CERTIFICATE IS NEGOTIABLE IN FULL AND IS SUBJECT TO THE PROVISIONS OF THE CHARTER AND BY-LAWS OF THE CORPORATION.

COMMUNICATIONS SATELLITE CORPORATION
SERIES I
DOMESTIC SHARE CERTIFICATE

is the owner of
ONE HUNDRED AND
NO SHARES OF
COMMON STOCK

This is to Certify that

FULLY PAID AND NON-ASSESSABLE SHARES, WITHOUT PAR VALUE, OF SERIES I COMMON STOCK

of Communications Satellite Corporation, incorporated in the State of New York, is hereby certified to be the property of the person or persons named in the reverse hereof, and the shares are not subject to any lien, claim, or charge of any kind, and the Corporation has caused this certificate to be signed by its duly authorized officers and its seal to be hereunto affixed.

Dated:

Robert J. Melamed



James P. McInerney
SPECIMEN

00000



September 17, 1964—The First Annual Meeting of COMSAT shareholders was held. The initial Board of Directors was succeeded by a Board comprising 12 directors elected by the shareholders and three appointed by the President of the United States with the advice and consent of the Senate. Of the 12 elected directors, six (Series I) were elected by the public shareholders and six (Series II) were elected by the carrier shareholders.

Following the First Annual Meeting, the Board of Directors consisted of (*front row, left to right*) George Meany, Presidential appointee; Leonard H. Marks, Series I; Eugene R. Black, Series II; Leo D. Welch, Series I; Joseph V. Charyk, Series I; James E. Dingman, Series II; George Killion, Series I; (*back row, left to right*) Horace P. Moulton, Series II; Ted B. Westfall, Series II; Douglas S. Guild, Series II; Frederic G. Donner, Presidential appointee; David M. Kennedy, Series I; Bruce G. Sundlun, Series I; Harold M. Botkin, Series II. Not shown in the picture is Clark Kerr, Presidential appointee.

October 10, 1964—At the request of the United States Government, COMSAT coordinated the arrangements for televising the 1964 Olympic ceremonies from Tokyo live to the United States via NASA's experimental satellite SYNCOM III and the U. S. Navy earth station at Point Mugu, California, modified by COMSAT for the event. This service heralded the new era to be opened 8½ months later when Early Bird began commercial operation.

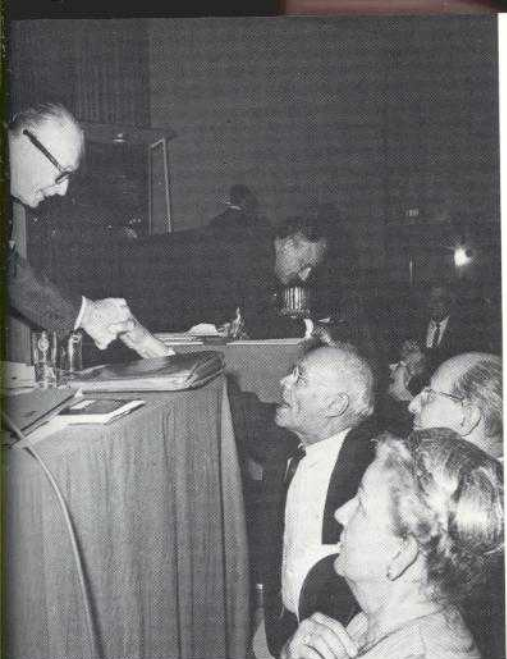



are to provide orbital messengers, not only of
speech, and pictures, but of thought and hope.

LYNDON B. JOHNSON
March 1965

1965

April 6, 1965—When Early Bird, the world's first commercial communications satellite, was launched from Cape Kennedy, a new communications era began. The event marked the first step toward a worldwide network of satellites linking peoples of many nations. Early Bird was the only mode of live transatlantic television, and it increased by nearly two-thirds the telephone capacity across the Atlantic.

Early Bird was emplaced in synchronous orbit 22,300 miles over the coast of Brazil by control signals transmitted from the Andover, Maine, Earth Station on command from the COMSAT Control Center in Washington, D.C. Vice President Hubert H. Humphrey and Sen. Walter F. Mondale watched the launch on a TV screen at COMSAT headquarters in Washington.

Command and control of Early Bird and later satellites was exercised by the Spacecraft Technical Control Center. The Operations Center supervises and monitors traffic routings for the global satellite system.

In the United States and abroad, public and press interest in the launch was intense.

May 12, 1965—In an interim decision, the Federal Communications Commission awarded to COMSAT the sole responsibility for the design, construction and operation of three initial U.S. earth stations for international communications.

This decision applied to the earth station at Andover, Maine, which was being leased by COMSAT from the American Telephone and Telegraph Company, and the proposed stations at Paumotu, Hawaii, and Brewster, Washington. On August 29 COMSAT and AT&T signed an agreement for the sale of the Andover station to COMSAT

EARLY BIRD ORBITAL DYNAMICS

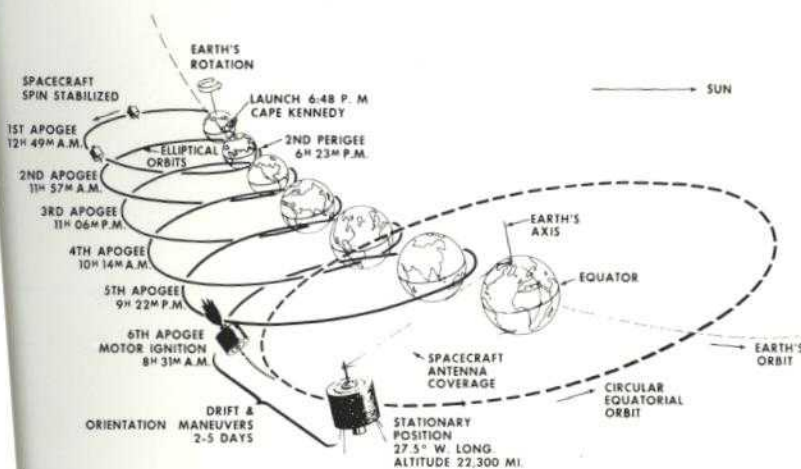

PLUNGING IN ORBIT

Early Bird settles into its nest — 22,300 miles high

EARLY BIRD, the world's first commercial communications satellite, moved obediently into a new orbit just north and west of the road of the equator yesterday after its 24-hour mission ended in frustration for Andover, Maine.

In accordance with those instructions, it entered its operational track, and moved into an orbit of 22,300 miles.

From that altitude, it will be able to see the entire Earth in a single sweep of its 24-hour orbit.

The mission was declared a success when the satellite was placed in its orbit at 10:15 a.m. EDT.

My goodness, it's not like I'm a good thing or not.

ANDOVER STATION SENDS SIGNALS TO SPACECRAFT; HANDLES TELEVISION WELL

WASHINGTON (AP) — Early Bird satellite communications station here today is handling television signals as well as the spacecraft's other duties.

However, Reiger said, the station is not yet capable of handling television signals. He said that only the small jets and the spacecraft's other duties will be handled by the station.

The sub-orbit will be fixed at the sixth rather than the fifth orbit.



Test of Early Bird's TV Heightens Optimism

By Howard Simon
A successful test of the satellite's ability to handle television signals today heightens optimism that the satellite will be used for a wide range of communications.

The test, which was conducted by the Andover station, showed that the satellite is capable of receiving and transmitting television signals. This is a significant step towards the satellite's use for global television broadcasting.

EARLY BIRD GETS 'EXCELLENT' MARK

Relays First Signal From 22,660 Mile Altitude

By EVERETT CLARK
WASHINGTON (AP) — The world's first commercial communications satellite today has been given a "first-class" mark by the Federal Communications Commission.

The FCC's decision, which was announced today, is a significant endorsement of the satellite's performance. It indicates that the satellite is capable of providing reliable and high-quality communications services.

Early Bird Orbit as First Link in a Global Communications Net

By EVERETT CLARK
WASHINGTON (AP) — The world's first commercial communications satellite today has been given a "first-class" mark by the Federal Communications Commission.

The FCC's decision, which was announced today, is a significant endorsement of the satellite's performance. It indicates that the satellite is capable of providing reliable and high-quality communications services.

'Pay-Phone' Satellite Racing Into Position

By David Hoffman
The world's first commercial communications satellite today has been given a "first-class" mark by the Federal Communications Commission.

The FCC's decision, which was announced today, is a significant endorsement of the satellite's performance. It indicates that the satellite is capable of providing reliable and high-quality communications services.

Clarín
Fundado en Agosto de 1941
DIRECTOR FUNDADOR ROBERTO MONTE
Buenos Aires, Viernes 9 de Abril de 1965

世界ダイヤル通話への道
アーサー・バー
LE LANCEMENT DU SATELLITE EARLY BIRD va marquer le début de l'utilisation commerciale de l'espace pour les communications téléphoniques

Is Rocket 'Satellite' Orbital
SATELLITE LOFTED FOR GLOBAL LINK
Continued From Page 1, Col. 1
The rain clouds telephone calls in the office already. The Early Bird left its pad at 8:48 P.M. Eastern standard time.

Una Nueva Cosmovisión
IMPULSADO por un poderoso cohete Delta de tres etapas, encuentra ya en órbita el primer satélite del mundo destinado al tráfico comercial de comunicaciones de larga distancia. Se trata del 'Early Bird' (Pájaro madrugador), el lanzamiento estuvo a cargo de la Administración Nacional de Aeronáutica y del Espacio.

240 回線
The satellite is capable of providing 240 telephone circuits for global communication. This is a significant milestone in the development of satellite-based telecommunications.

De notre envoyé spécial NICOLAS VICHNEY
Main les technologies de la communication sont en train de changer. Le satellite est le symbole de cette révolution.

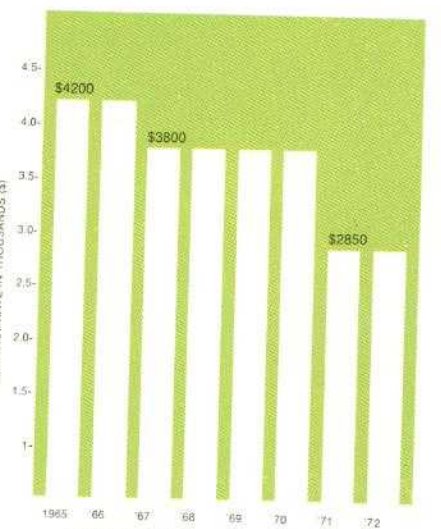
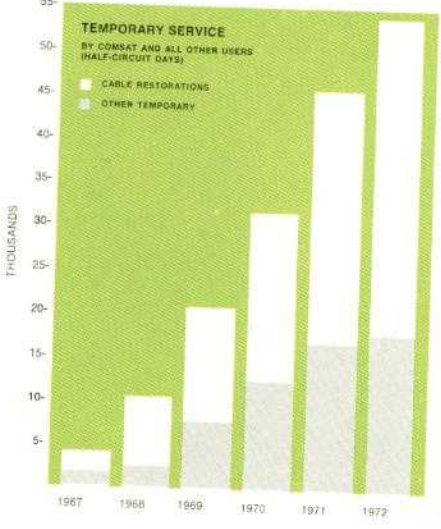

June 18, 1965—During a transatlantic submarine cable outage, Early Bird was used to restore service, the first such use of a satellite. Restoration of cable service via the satellite system has increased each year since Early Bird.

June 27, 1965—COMSAT established its first tariff—\$4,200 per month for a voice-grade half circuit between the U.S. and Western Europe. COMSAT has reduced its rates twice since then.

June 28, 1965—High government officials in the United States and Europe exchanged greetings via Early Bird in a transatlantic ceremony introducing commercial service. Participants in the early transmissions included British Prime Minister Wilson, Canadian Prime Minister Pearson, West German Chancellor Erhard, President Johnson, former President Eisenhower and Field Marshal Viscount Montgomery, Senator Warren G. Magnuson, and E. William Henry, Chairman of the Federal Communications Commission.

Before its inauguration Early Bird had successfully demonstrated television, voice, and facsimile transmission.

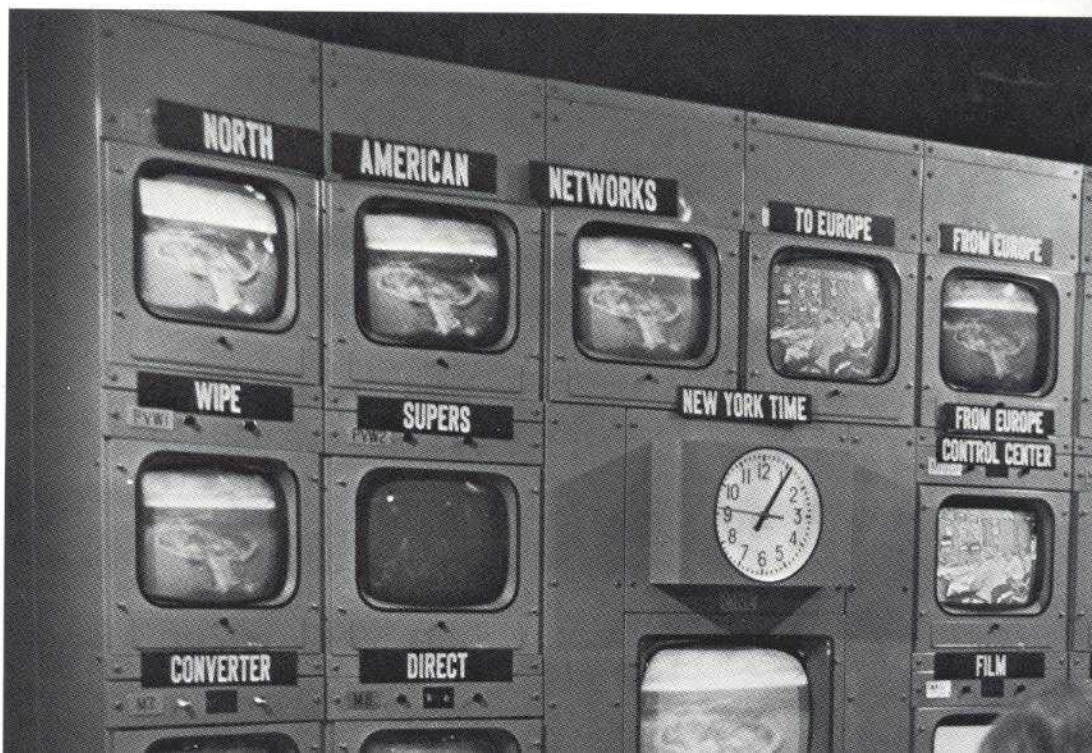
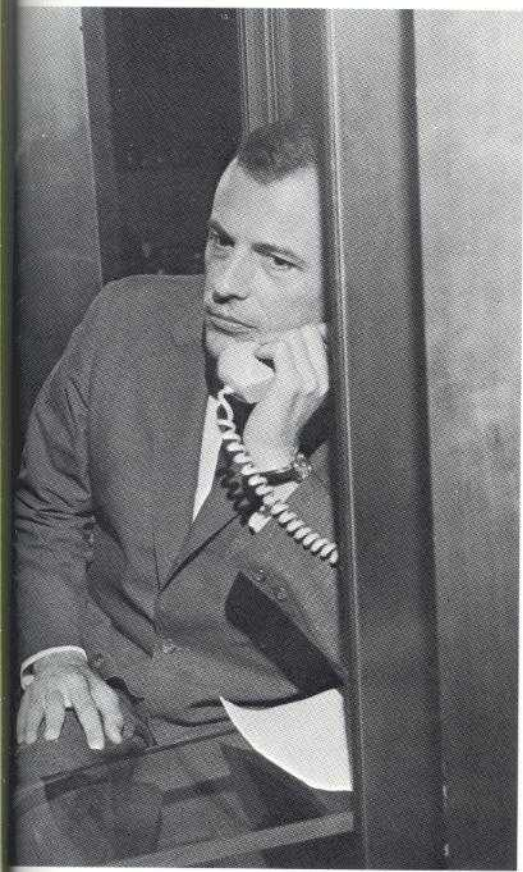
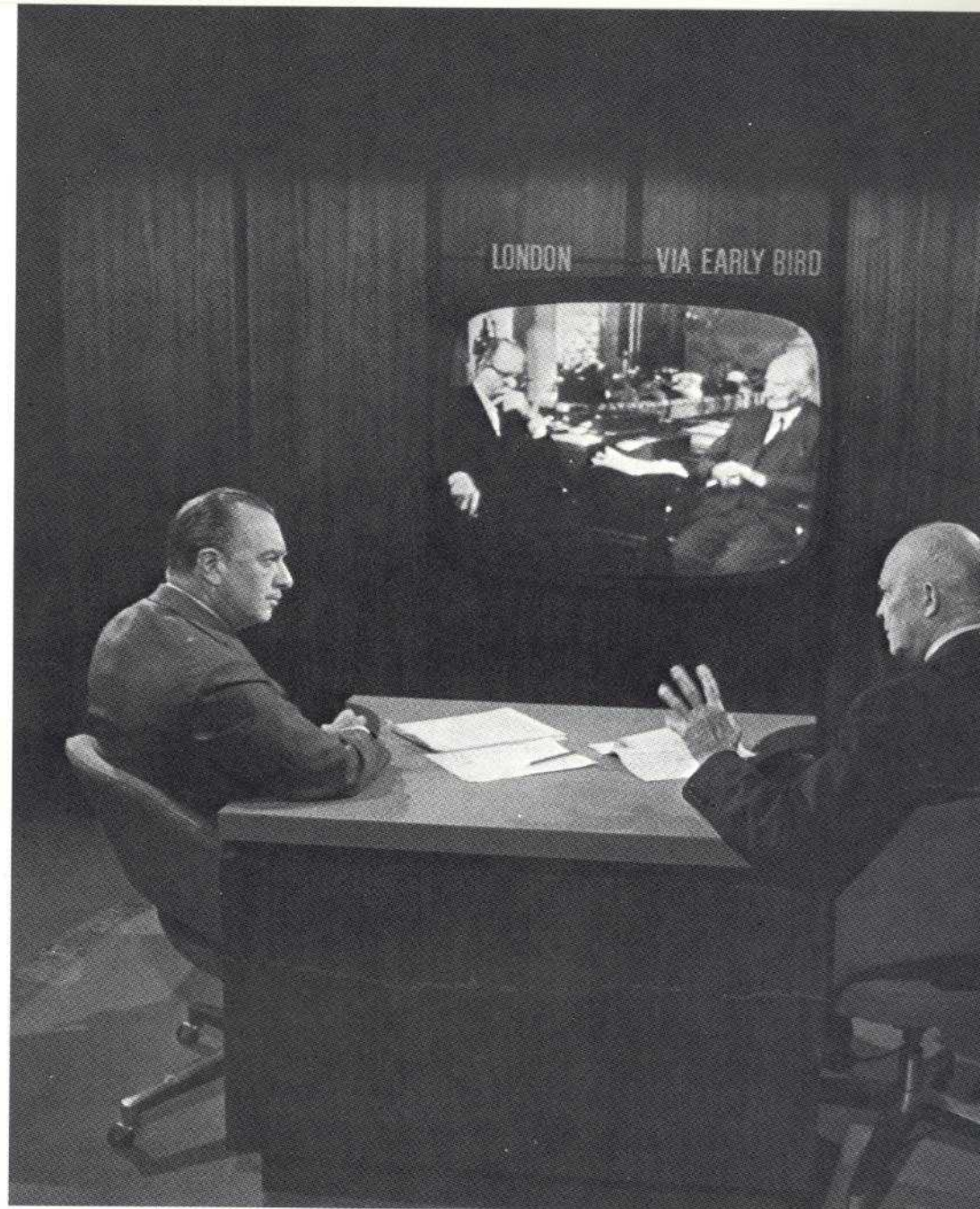
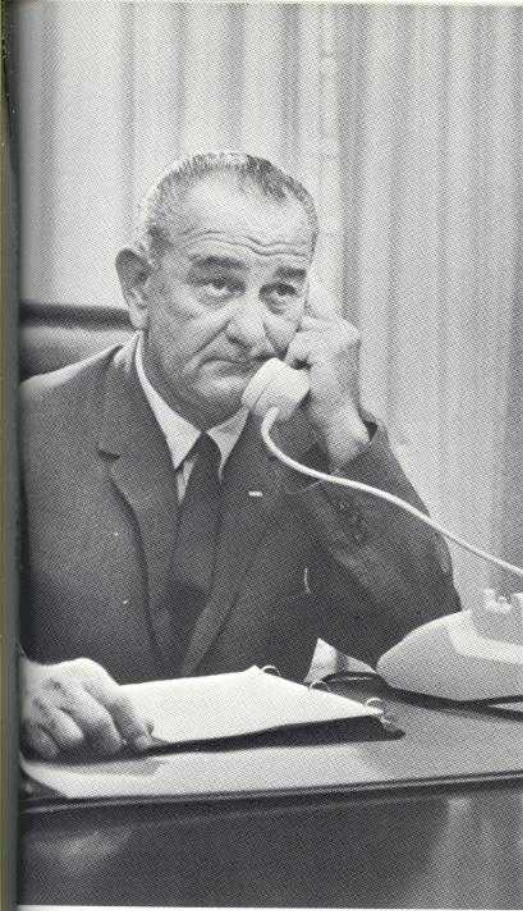

November 15, 1965—To provide early communications support for the National Aeronautics and Space Administration's Apollo moon-landing program, COMSAT awarded a contract to Hughes Aircraft Company for the INTELSAT II satellites.

The INTELSAT II series of satellites provided worldwide communications services associated with the early Apollo missions, as well as other commercial services. COMSAT also procured three transportable earth stations to be used as links in providing the Apollo services. Also, NASA established shipboard antennas for the relay of Apollo data via satellite.

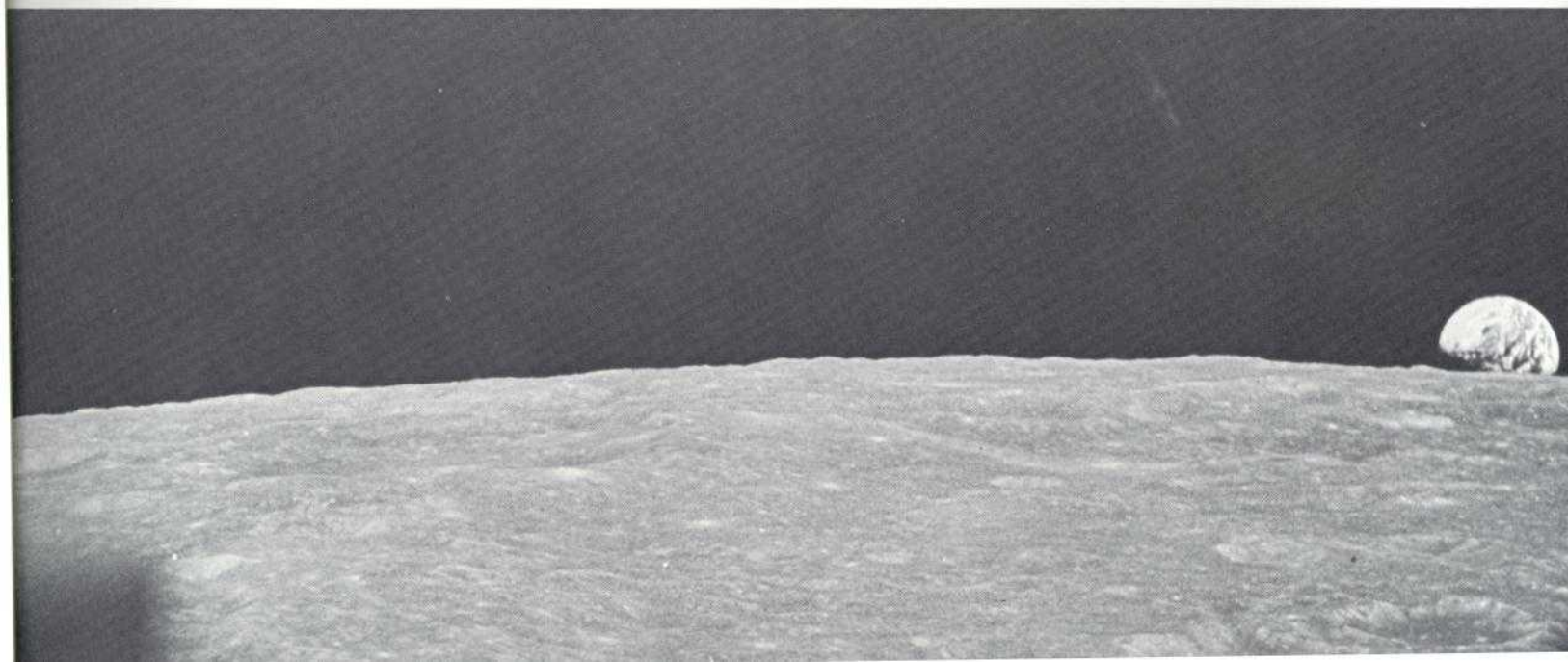
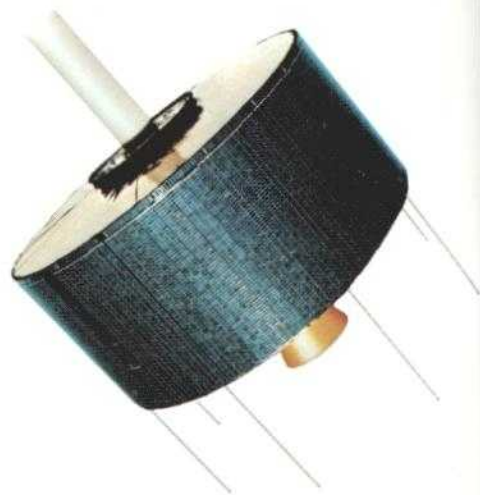

November 14, 1965—Ground-breaking ceremonies were held for the Brewster, Washington, Earth Station. The station entered commercial service on December 8, 1966.

Among the officials who attended the ground-breaking were Sen. Warren G. Magnuson, Sen. Henry M. Jackson, Rep. Thomas S. Foley, all of Washington State, and COMSAT Chairman James McCormack.

December 27, 1965—Ground-breaking ceremonies were held for the Paumalu, Hawaii, Earth Station. At the groundbreaking ceremony were Sen. Daniel K. Inouye, Rep. Patsy T. Mink, Lt. Gov. William Richardson of Hawaii, Douglas S. Guild, President of Hawaiian Telephone Company and a COMSAT director, and James McCormack, Chairman of COMSAT. The station entered commercial service on December 8, 1966.



1966

COMPONENT ARRANGEMENT OF INTELSAT II

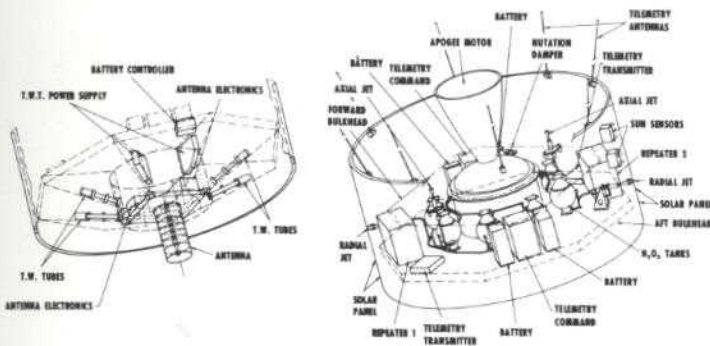

COMPONENT ARRANGEMENT OF INTELSAT III

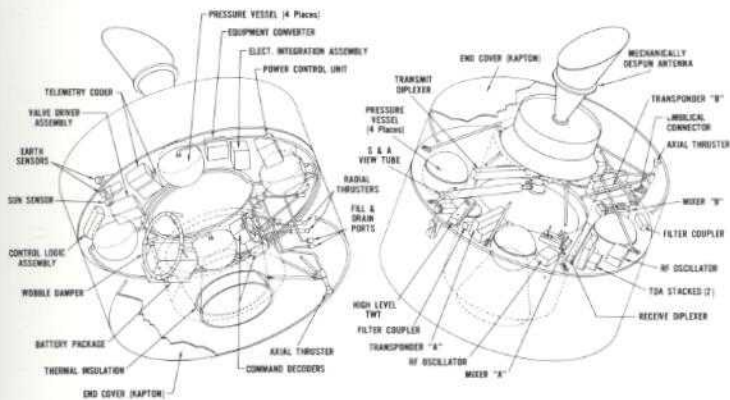

June 23, 1966—COMSAT as Manager for INTELSAT awarded a contract to TRW Systems, Inc., for six INTELSAT III satellites to establish the initial global system.

The first launch was planned for 1968. These satellites were to provide five times the power of the INTELSAT II satellites, sufficient capacity to transmit television without relinquishment of circuits for voice service, and full multiple access capability.

August 1, 1966—In its first of several formal proposals for U.S. domestic satellite services, COMSAT asked the FCC for authority to establish a multipurpose service that would meet the needs of a wide range of communications users in the United States.

October 26, 1966—During the launch of the first INTELSAT II satellite, the apogee motor malfunctioned and synchronous orbit was not attained.

All communications equipment aboard the satellite functioned normally. From its elliptical orbit, the satellite provided limited commercial service, including live TV transmission between the U.S. Mainland and Hawaii and temporary telephone circuits between these points.

Among the commercial services provided by the satellite was television of a Notre Dame-Michigan State football game, the first live TV between the U.S. Mainland and Hawaii.

December 3, 1966—The tracking, telemetry, and command station (TT&C) at Paumalu entered service. This was the first specialized TT&C facility in the INTELSAT system. It was followed by three similar facilities—at Fucino, Italy; Andover, Maine; and Carnarvon, Australia.

Later these TT&C stations were modified for the INTELSAT III satellites and improved again for the INTELSAT IV's.

December 7, 1966—The FCC authorized COMSAT to construct and operate three additional U.S. earth stations at Etam, West Virginia; Cayey, Puerto Rico; and Jamesburg, California. At the same time, the FCC reduced COMSAT's ownership interest in the U.S. stations from 100 percent to 50 percent, with the remaining 50 percent to be divided variously among other U.S. international carriers.

TOP VIEW



SIDE VIEW

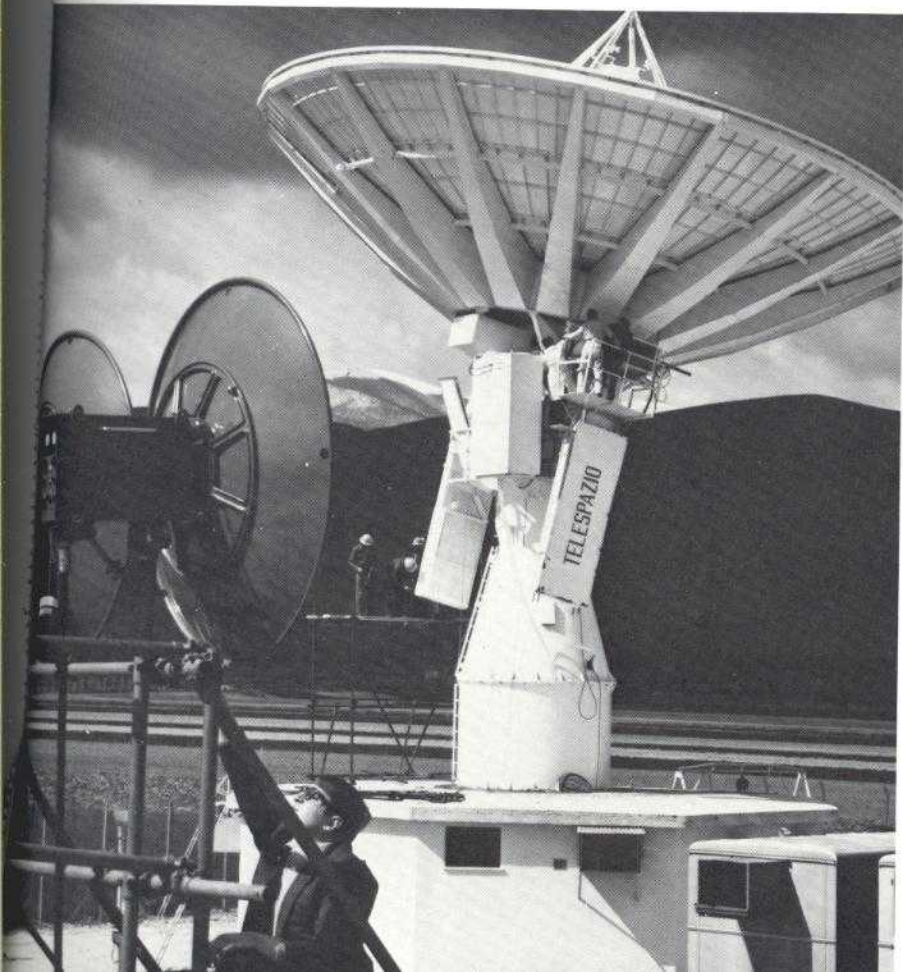
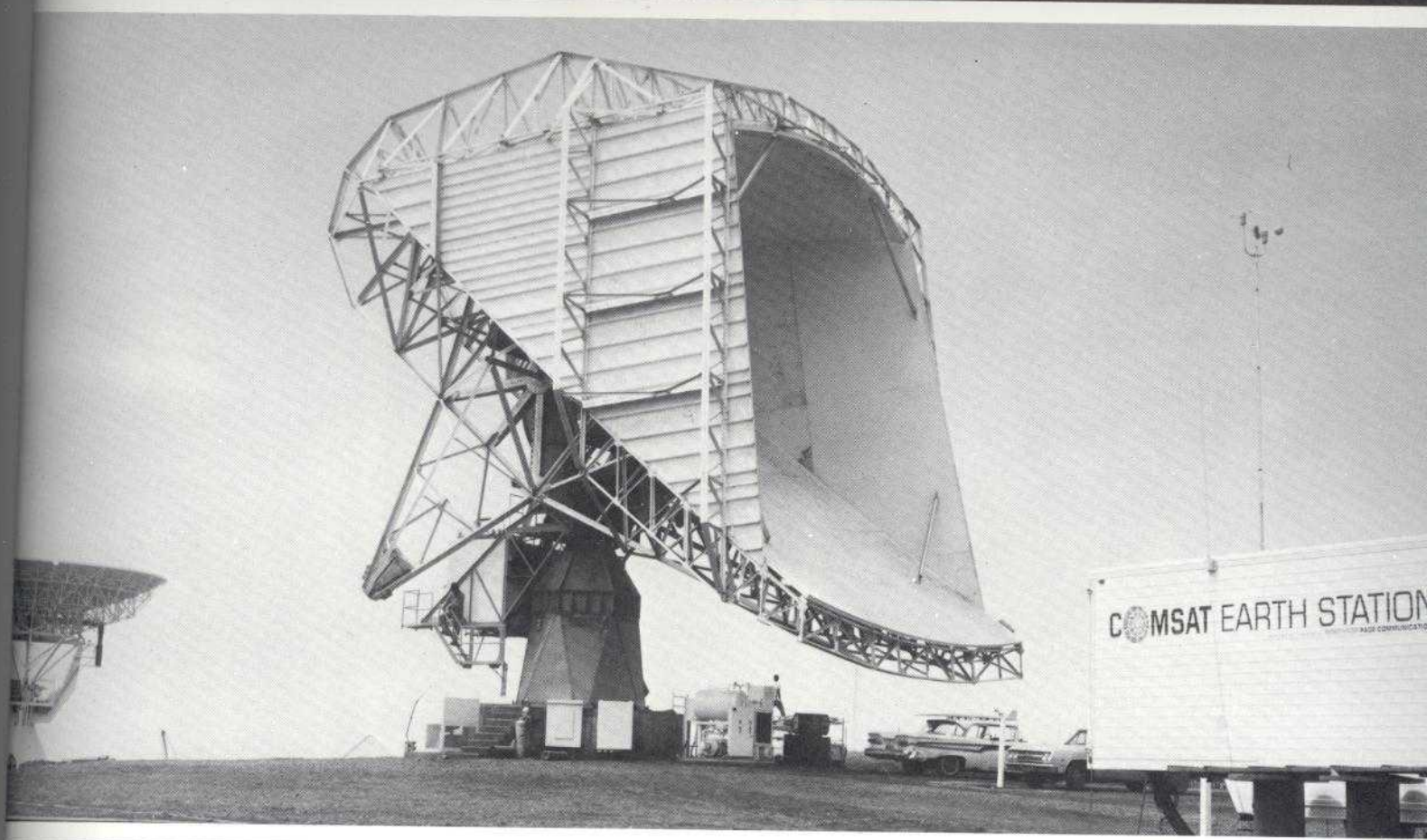



1967

January 11, 1967—The second INTELSAT II satellite was successfully launched and emplaced in synchronous orbit. It provided the first full-time satellite service over the Pacific.

March 22, 1967—The third INTELSAT II satellite was successfully launched, then positioned in synchronous orbit over the Atlantic Ocean.

As with all other INTELSAT missions, launch services were provided by the National Aeronautics and Space Administration to COMSAT as Manager for INTELSAT. Each of the launches took place at the Air Force's Eastern Test Range at Cape Kennedy, Florida.

September 27, 1967—The fourth INTELSAT II satellite was successfully launched and put into Pacific service on November 4, providing a second full-time satellite in that region.

This was the third consecutive successful Series II launch following a failure of the first satellite in the series to achieve synchronous orbit as a result of a malfunction during apogee motor firing.

This also was the fifth consecutive successful mission for INTELSAT by a Delta vehicle. The Deltas performed satisfactorily on the Early Bird launch and each of the Series II launches.

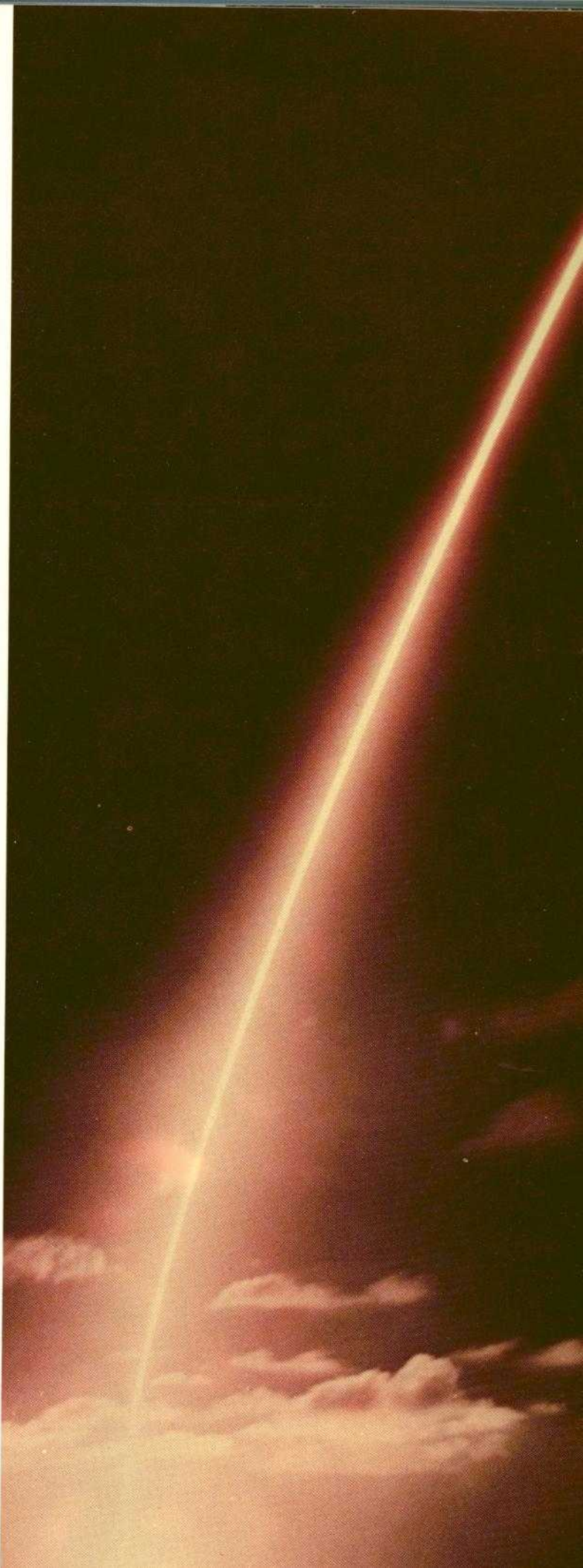
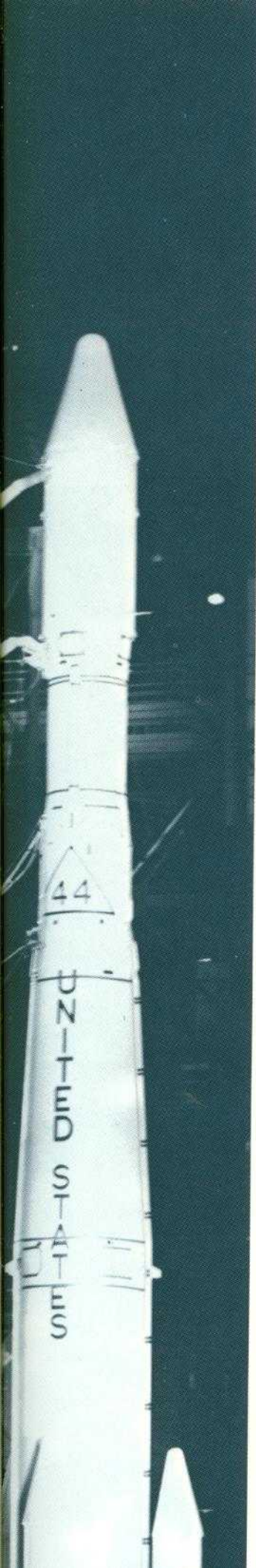

January 26, 1967—Ceremonies in Washington and Tokyo inaugurating commercial satellite service between the United States and Japan were televised live between the two capitals. Those who participated included Sen. Warren G. Magnuson, Chairman of the Senate Commerce Committee; Rosel H. Hyde, Chairman of the Federal Communications Commission; Rep. Harley O. Staggers, Chairman of the House Interstate and Foreign Commerce Committee; COMSAT Chairman James McCormack in Washington; and COMSAT President Joseph V. Charyk in Tokyo.

April 4, 1967—COMSAT substantially reduced its rates for telephone and television service by either Early Bird or the Atlantic INTELSAT II satellite between the United States and Western Europe.

May 1, 1967—Pursuant to a Federal Communications Commission order, COMSAT commenced full commercial operations, a sign that its developmental stages were behind, and began conventional accounting practices.

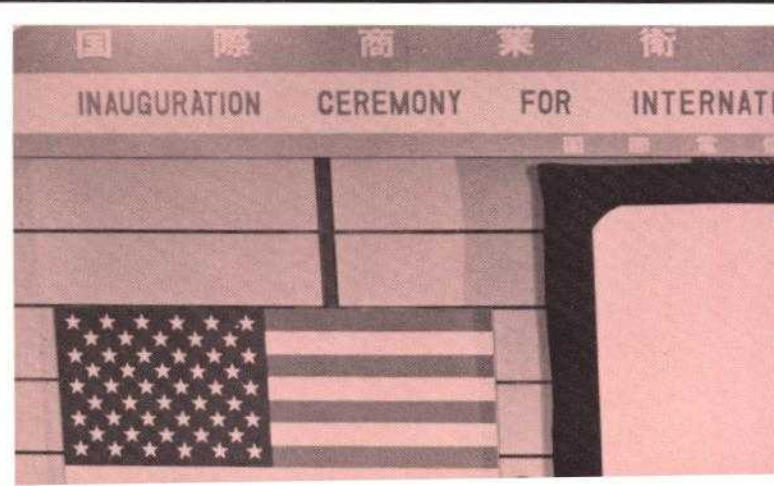

September 18, 1967—The first live transoceanic telecast to the home country of a visiting head of state took place upon the arrival at the White House of President Saragat of Italy.

The telecast also was the formal inaugural television program from the United States to the new, second antenna at the Fucino, Italy, Earth Station.

In addition to President Johnson and President Saragat, those present for the event included Secretary of State Dean Rusk; Sen. John O. Pastore,

Chairman of the Communications Subcommittee of the Senate Commerce Committee; and COMSAT Chairman James McCormack.

December 31, 1967—For the fourth quarter of the year, COMSAT realized a net operating profit for the first time. Heretofore, COMSAT had lost money on satellite operations, although it had realized net income because of income from temporary cash investments.

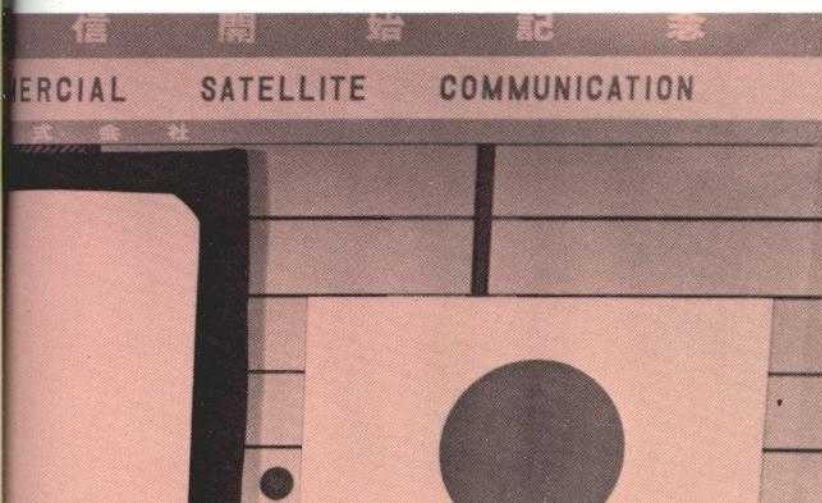
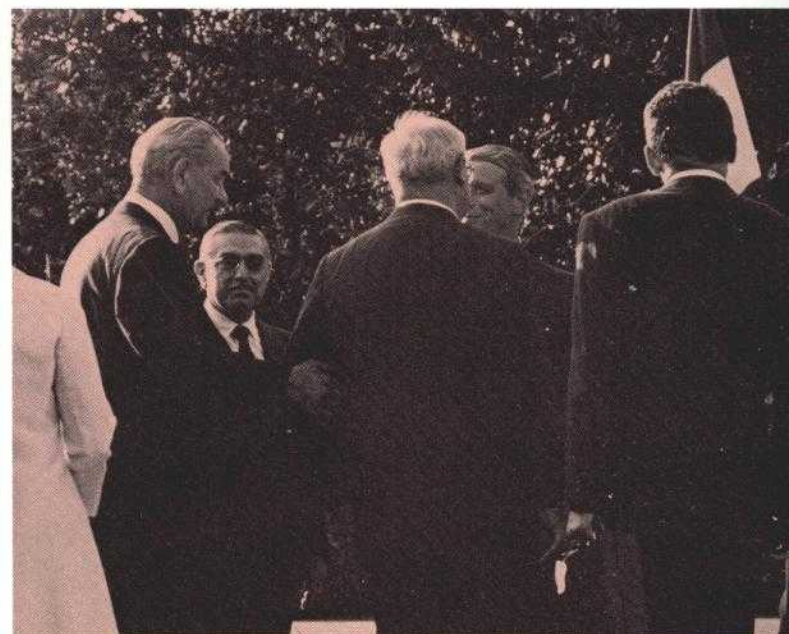
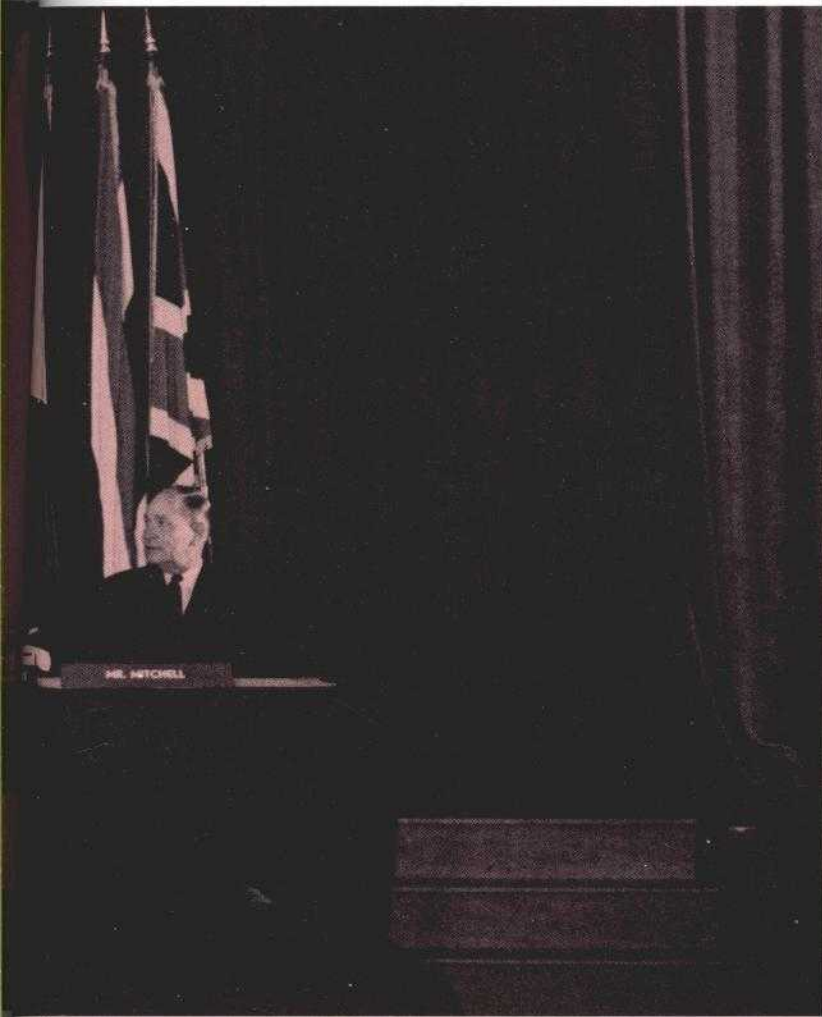

The role of communications is not limited to commercial use. It must also provide a "network for knowledge" so that all peoples can share the scientific, educational, and cultural advances of this planet. Failure to reach these goals can only contribute to apathy, ignorance, poverty and despair in a very large part of the world. Success in our telecommunications policies can be a critical link in our search for the understanding and tolerance from which peace springs. Communication by satellite is a tool—one of the most promising which mankind has had thus far—to attain this end. We must use it wisely and well.

LYNDON B. JOHNSON
April 1968

1968

September 18, 1968—The first launch attempt in the INTELSAT III series was unsuccessful. The launch vehicle was destroyed on command from the range safety officer when it veered out of control during the first stage firing.

December 1, 1968—The 97-foot antenna at the Jamesburg, California, Earth Station, began commercial operation with a Pacific satellite handling all forms of overseas communications—multi-channel telephone, telegraph, data, facsimile, and television.

December 18, 1968—The second INTELSAT III launch was successful, and the satellite was put into service over the Atlantic Ocean. These satellites, with five times the capacity of the INTELSAT II's, were the first designed expressly for global service.



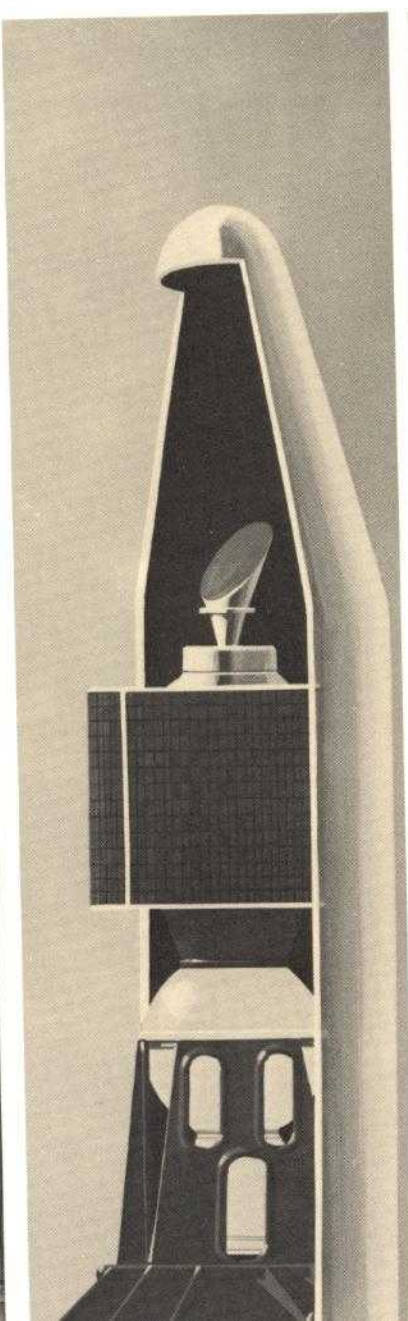
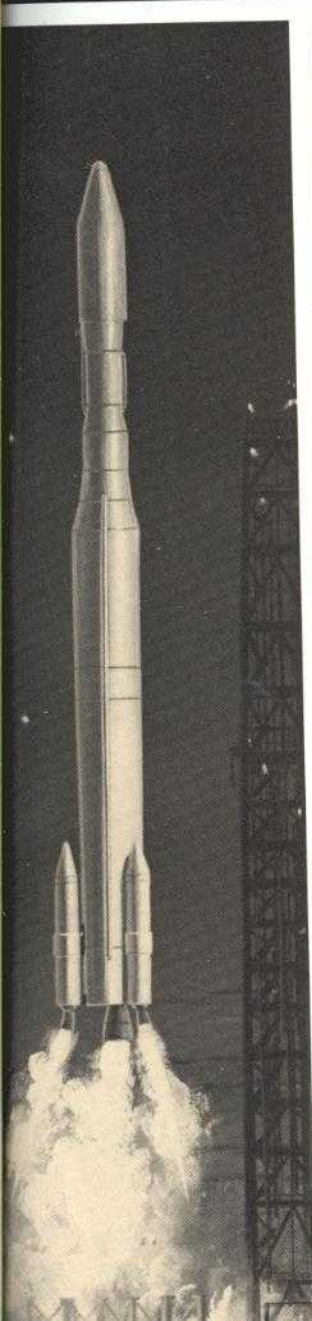
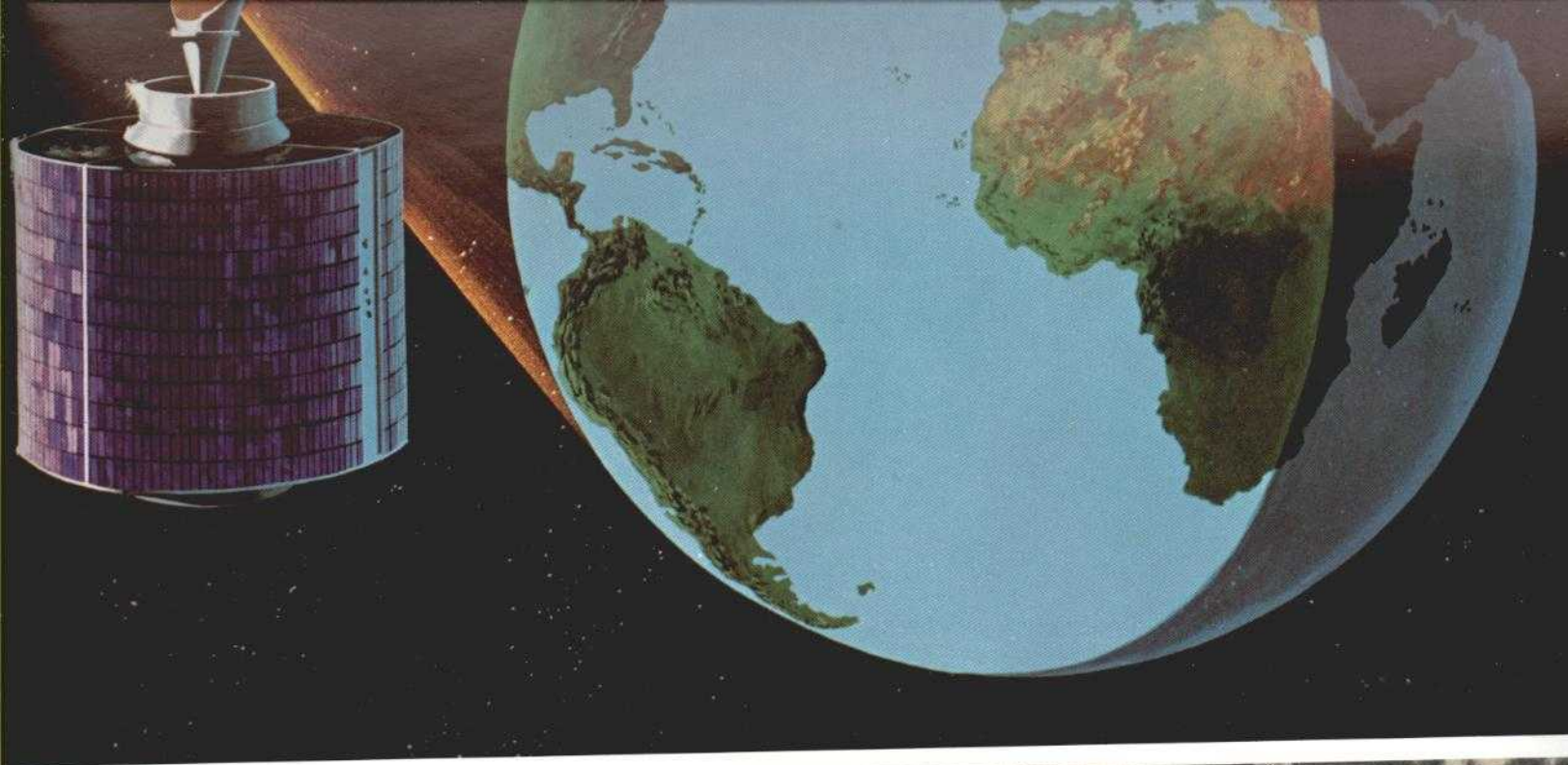

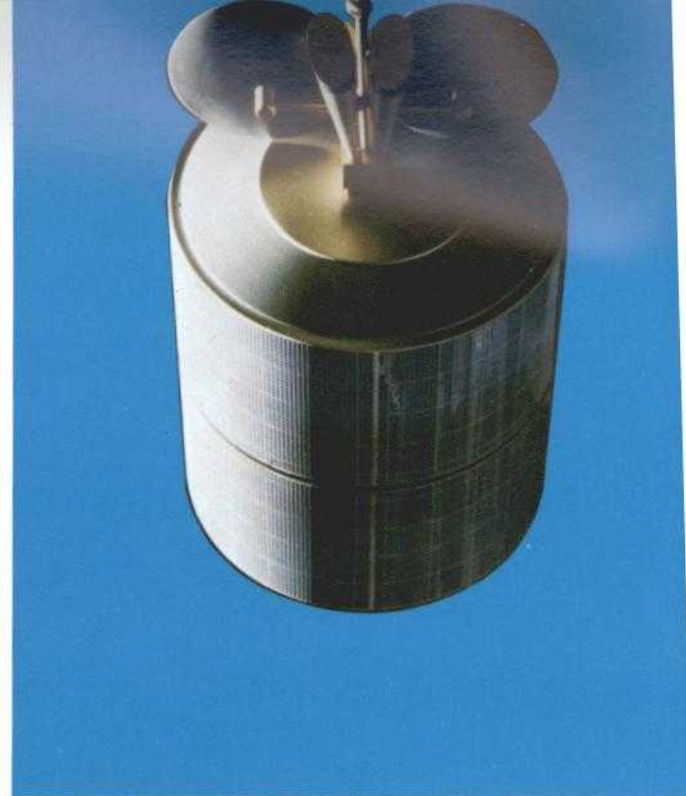

October 18, 1968—A contract for the manufacture of the INTELSAT IV satellites was awarded to Hughes Aircraft Company, with a provision for extensive foreign participation in the subcontracts. These advanced, fourth-generation satellites were designed to provide up to five times the capacity of the INTELSAT III's and meet global system requirements through the first half of the 1970's.

December 1, 1968—Another major step during 1968 was a second large (97-foot diameter) antenna at the Paumalu, Hawaii, station. The new antenna, together with the earlier 85-foot antenna and the 42-foot antenna for tracking, telemetry, and command, made Paumalu the largest earth station in the world. Later, multiple antennas at Goonhilly Downs, England, and Raisting, Germany, made these stations larger than Paumalu.

Among the expanded services provided by the satellite system during 1968 were TV coverage of the Winter and Summer Olympics, the Presidential inauguration and Project Apollo.

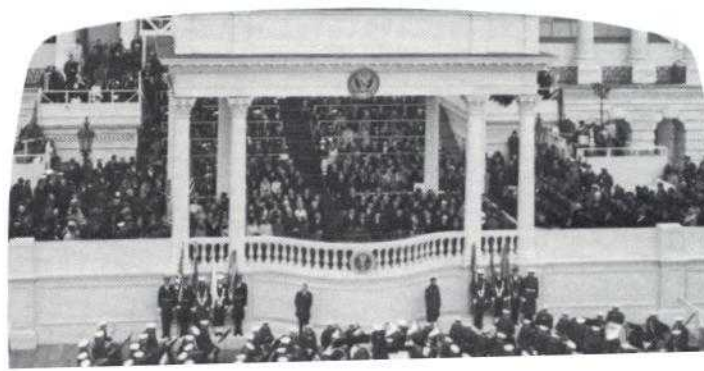

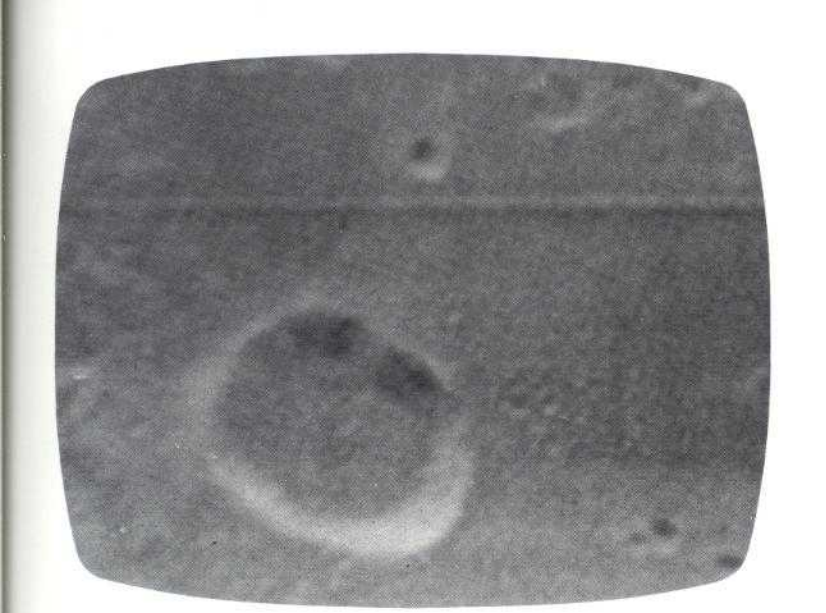
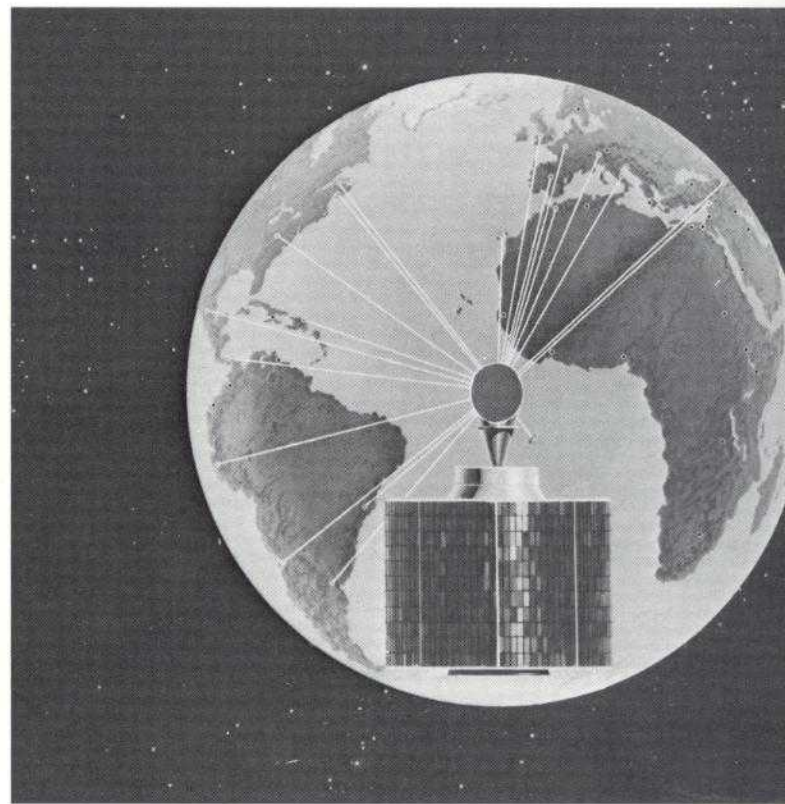
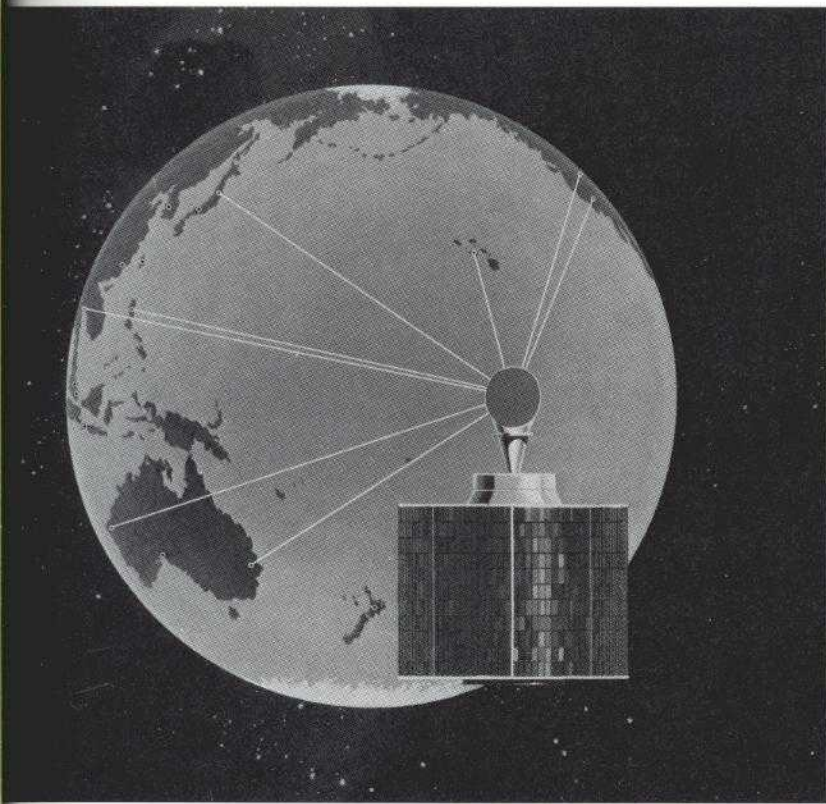

1969



January 6, 1969—The Etam, West Virginia, Earth Station entered service. At a dedication held earlier Rep. Harley O. Staggers was the speaker. The new station was equipped with a 97-foot diameter antenna for optimum capability.

January 25, 1969—The Cayey, Puerto Rico, Earth Station entered service. At a dedication held earlier, Luis Ferre, Governor of Puerto Rico, was the main speaker. He and James McCormack, COMSAT Chairman and Chief Executive Officer, cut the ceremonial ribbon.

February 5, 1969—The third INTELSAT III satellite was successfully launched, positioned in synchronous orbit, and placed in commercial service over the Pacific Ocean on February 16.

Five more III's were launched later in 1969 and in 1970. Of the eight satellites launched in the INTELSAT III series, five were placed in regular service, two failed to achieve transfer orbit due to launch vehicle malfunction, and one failed to achieve synchronous orbit due to a malfunction during apogee motor firing.

The launch vehicle used for the INTELSAT III was the Long Tank Delta, an improved version, with a greater payload capability, of the vehicle used for Early Bird and the INTELSAT II satellites.

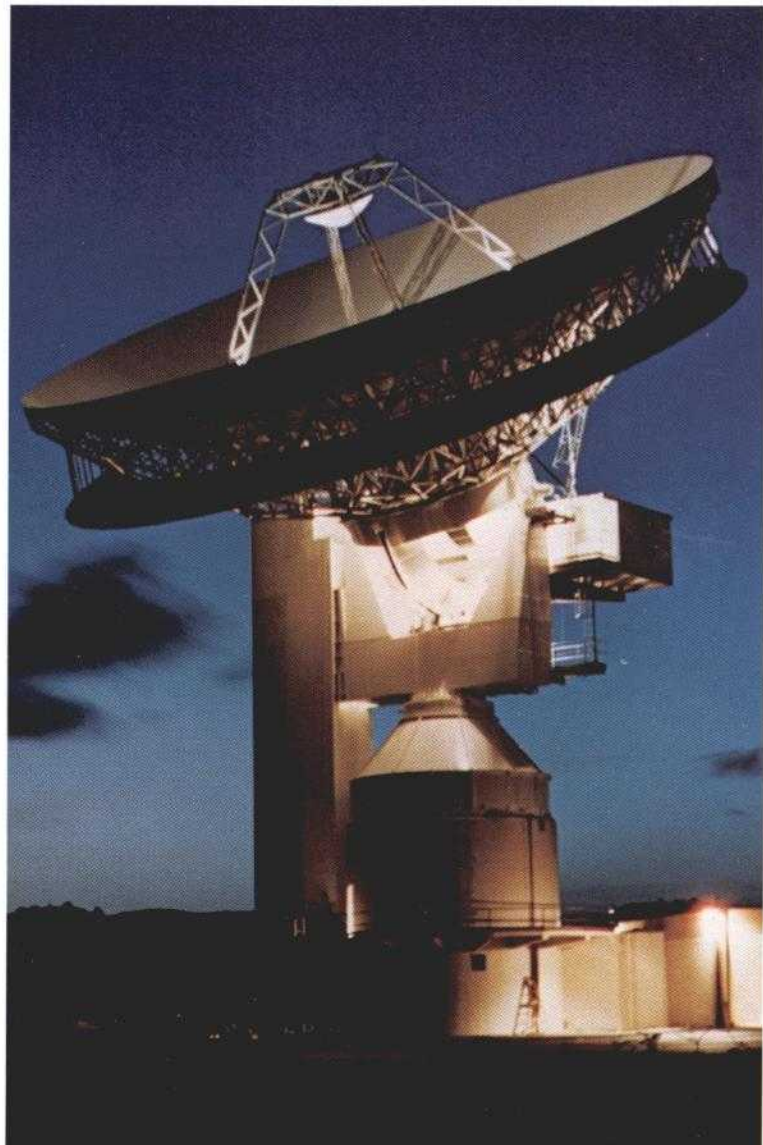
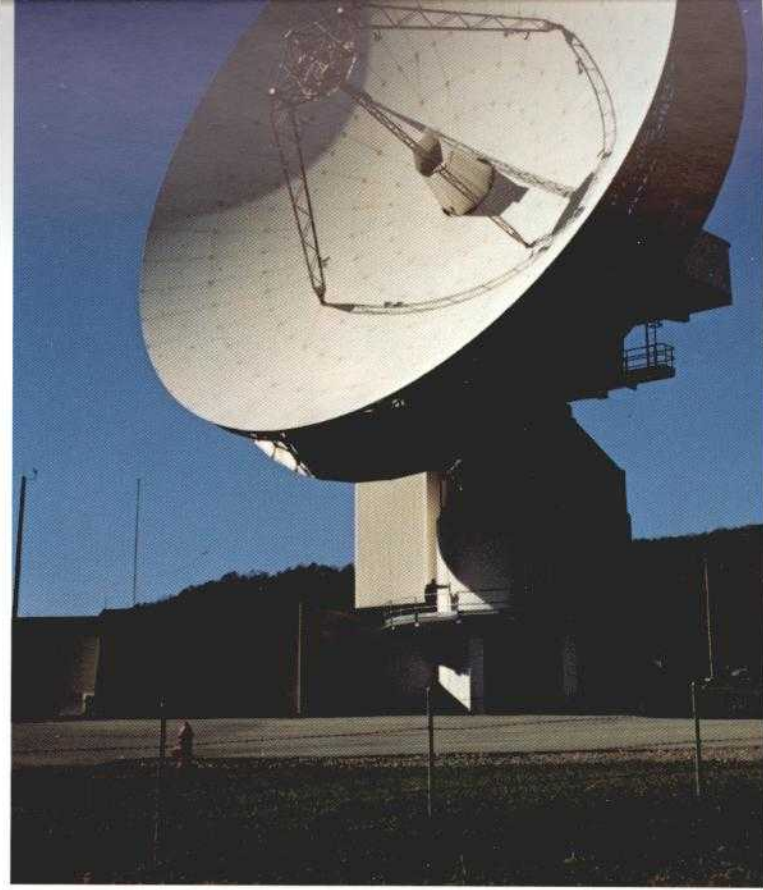
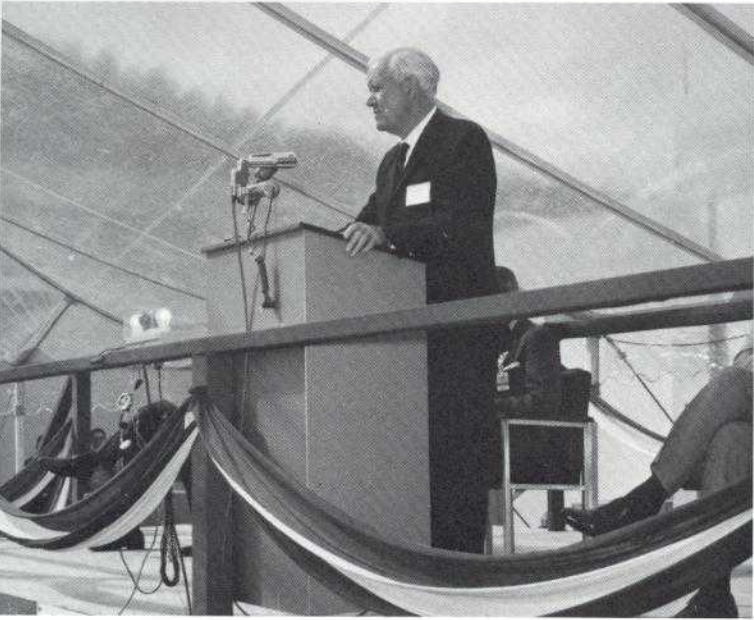

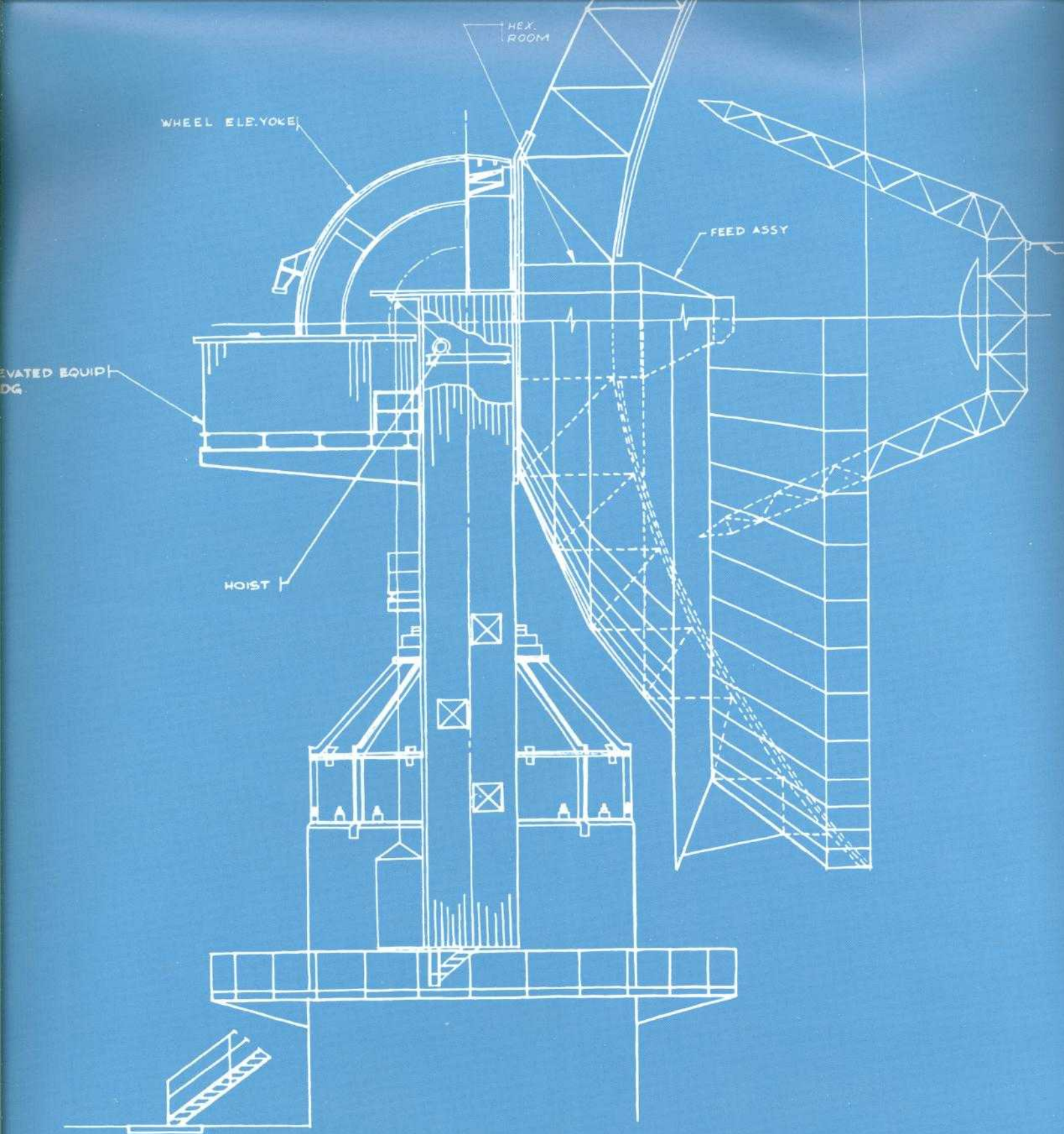

Earth station development around the world was given strong impetus by the INTELSAT III satellite program. As a result, 1969 brought the largest number of new earth station facilities as 22 new antennas went into commercial operation.

July 1, 1969—Full global coverage was established when an INTELSAT III satellite over the Indian Ocean began commercial service. This was the first satellite service in the Indian Ocean region.

The Indian Ocean satellite was the INTELSAT III, F-3, which had been launched for Pacific service on February 5, 1969. It was repositioned over the Indian Ocean after the III, F-4, began Pacific service.

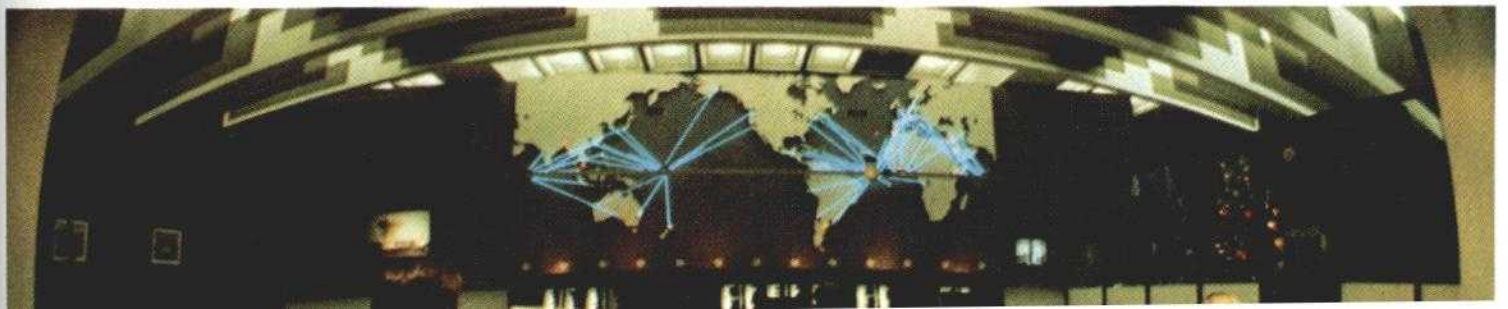
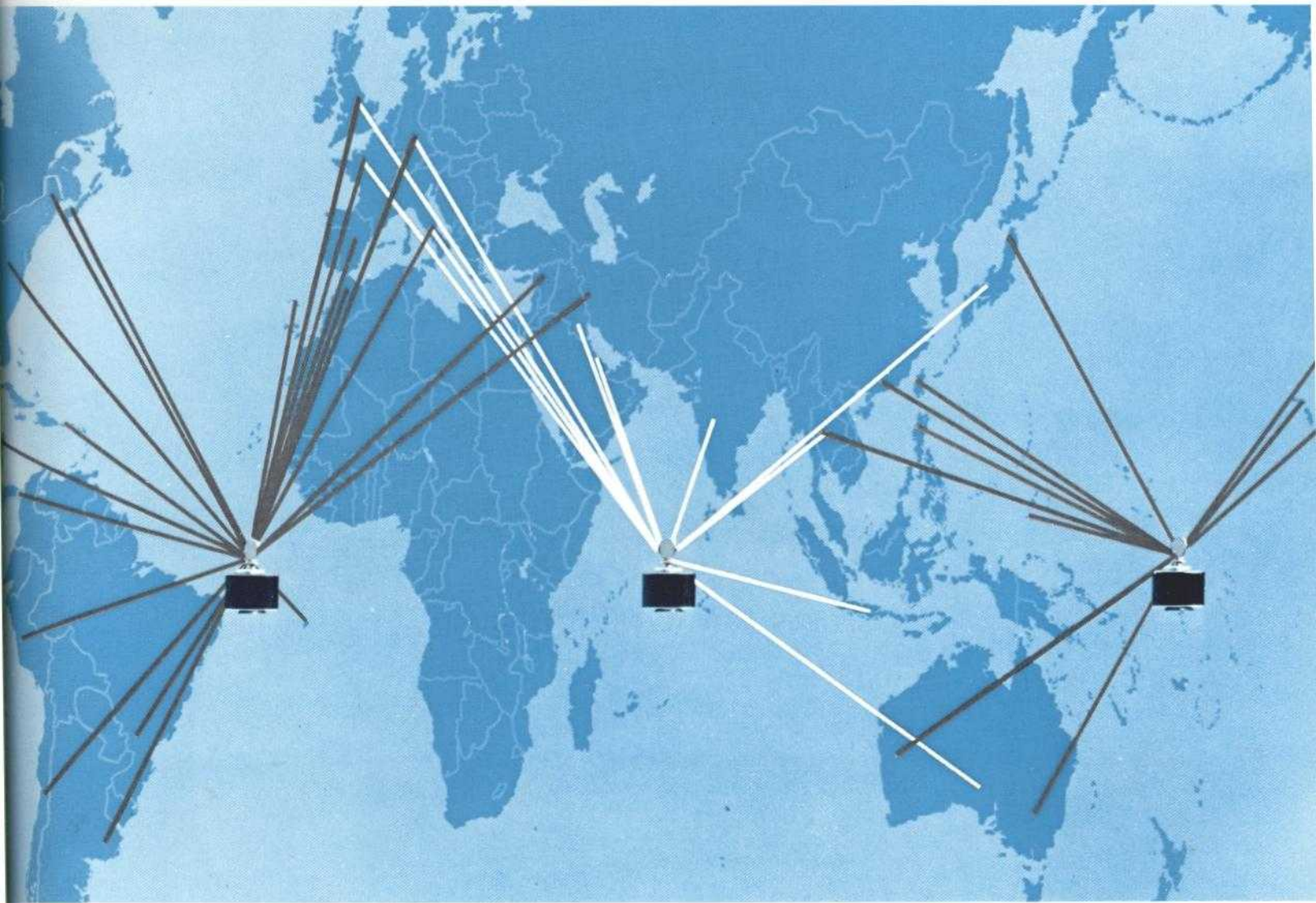



July 20, 1969—Satellite television coverage of the Apollo 11 moon-landing mission made it the most widely viewed event in history. Neil Armstrong's first steps on the moon were an historic milestone in the U.S. space program. Television coverage of the Apollo 11 mission was seen throughout the world, live via satellite.

In addition, the satellite system provided vital communications support services to the National Aeronautics and Space Administration throughout the Apollo program.

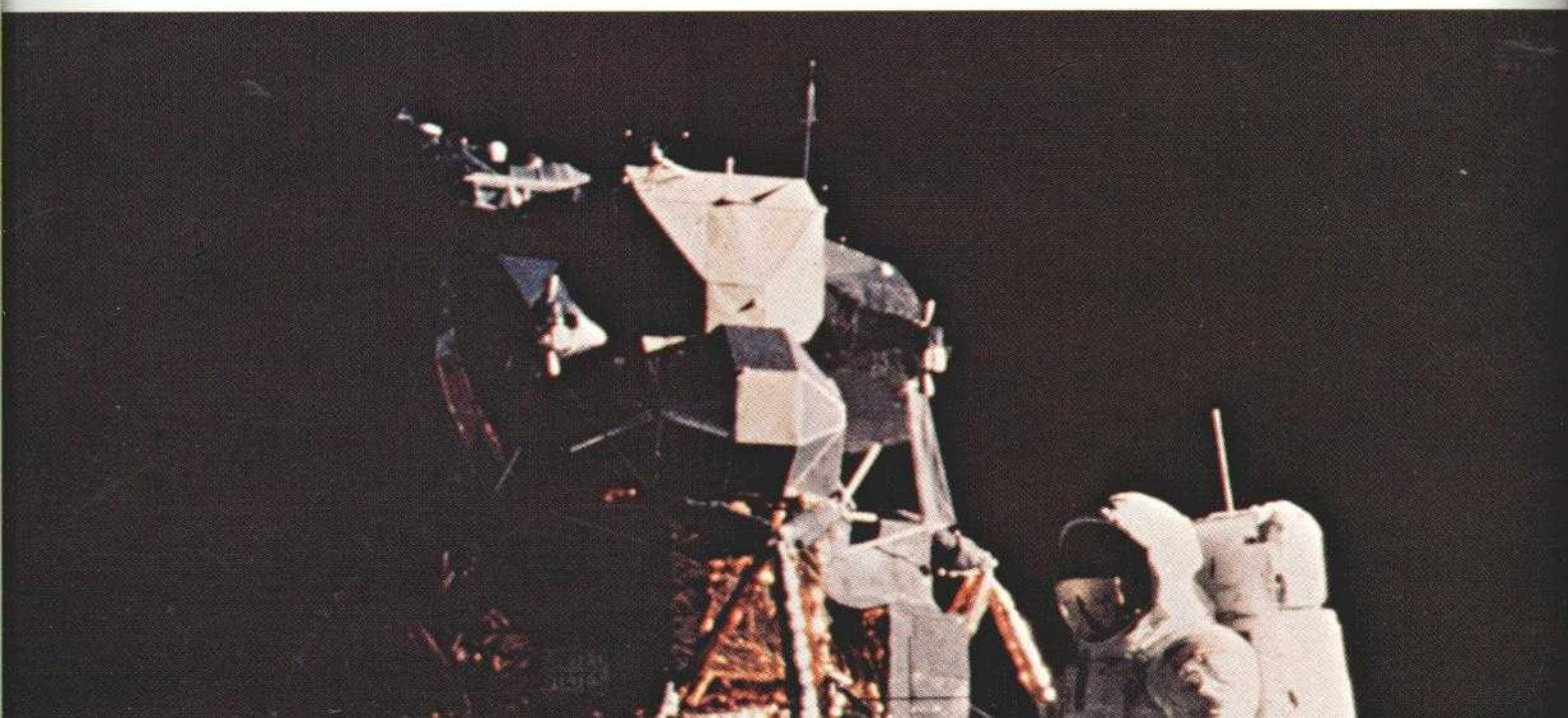
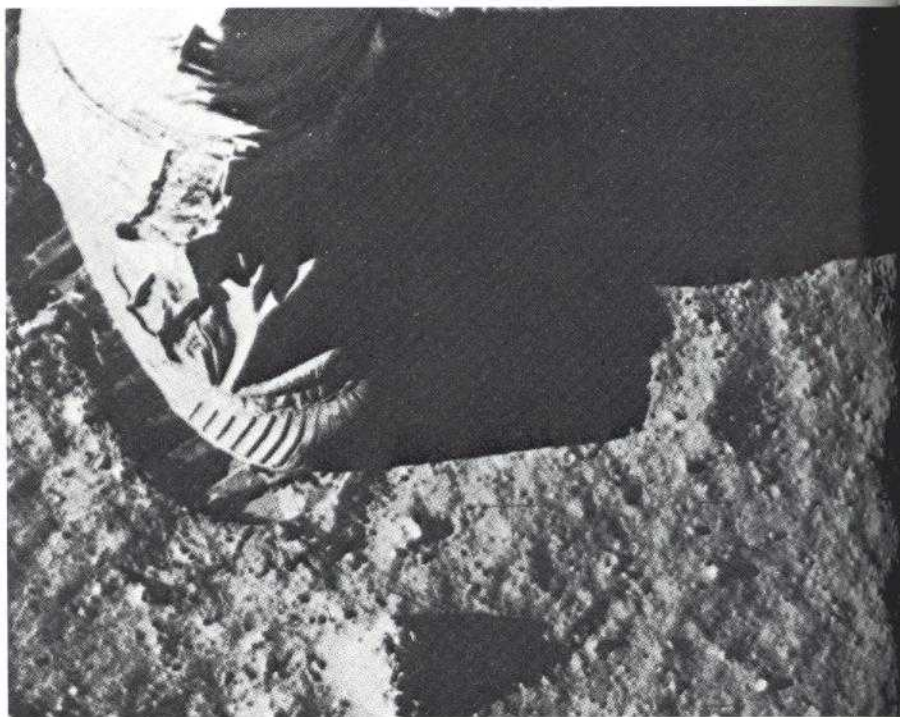
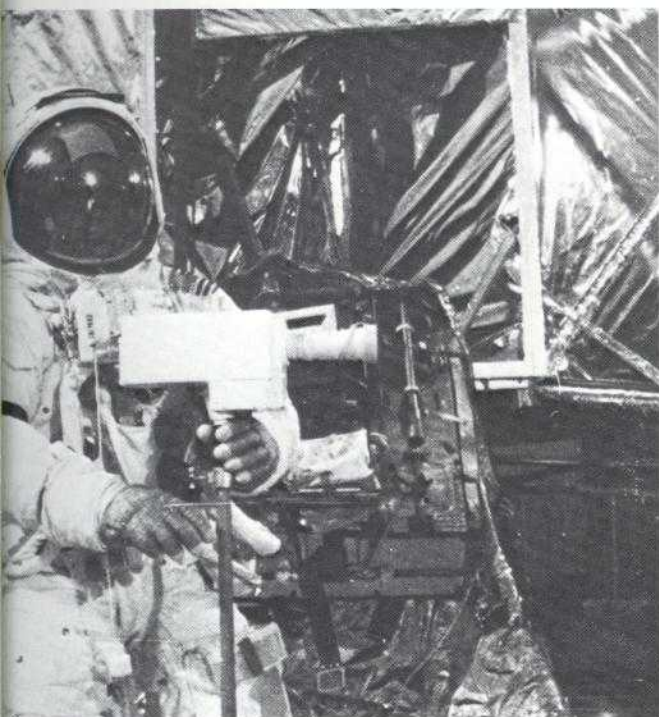

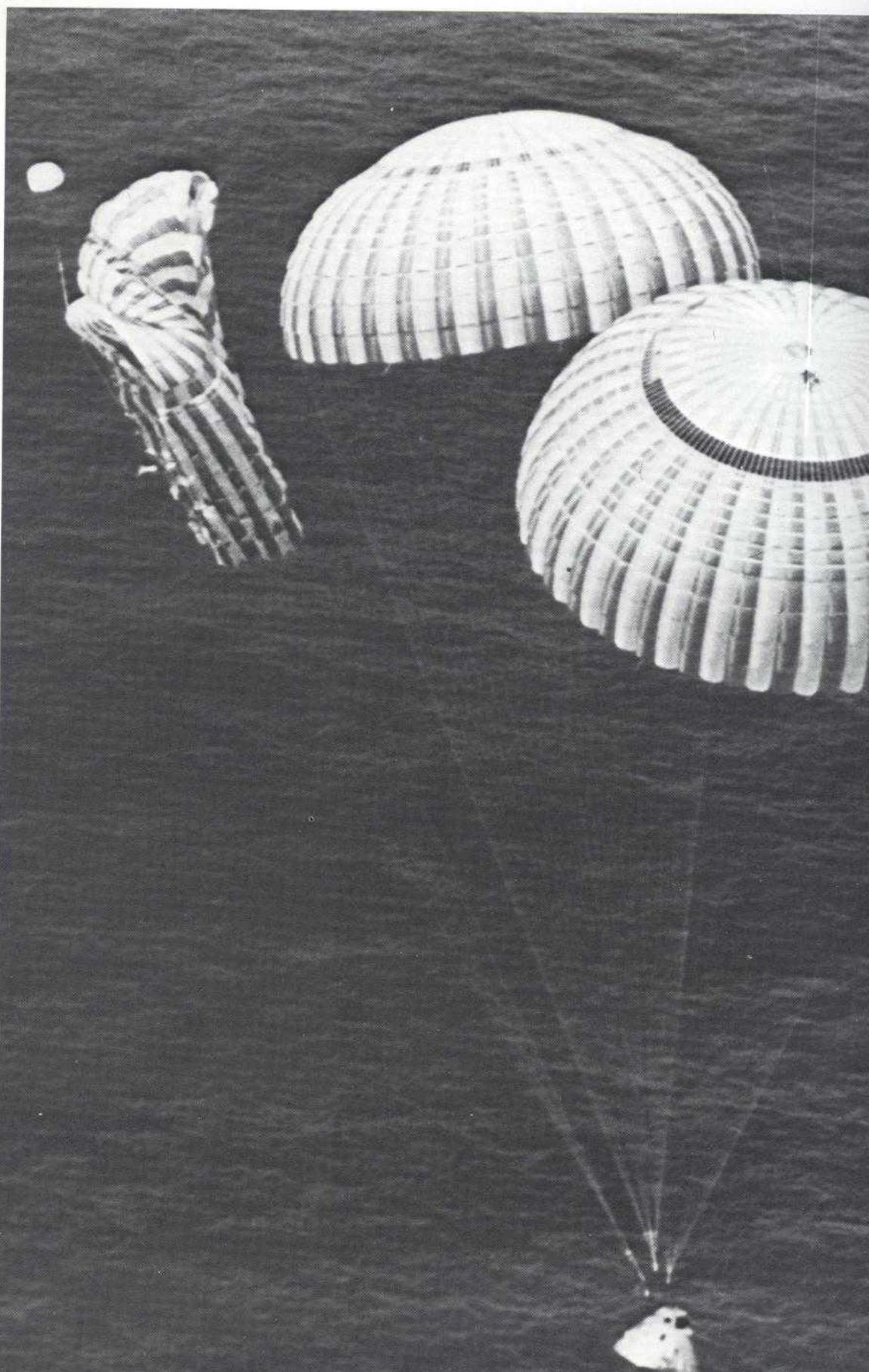
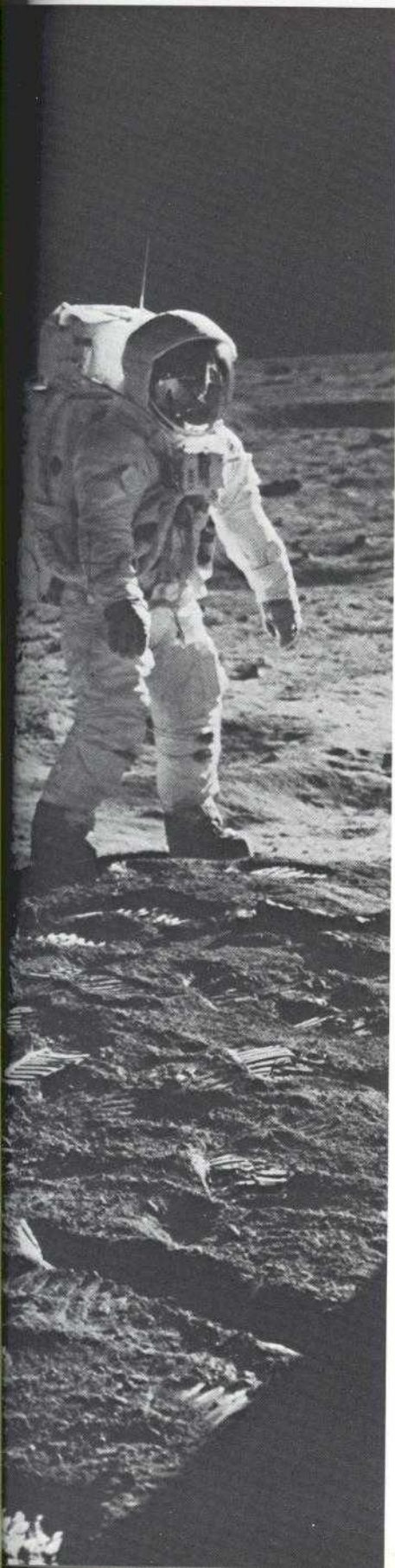

February 24, 1969—The International Conference on Definitive Arrangements for INTELSAT convened in Washington, D. C., then adjourned on March 21 while its work was carried forward by a preparatory committee. The international conference was attended by representatives of virtually all of the 68 nations then in INTELSAT plus observers from several other nations.



September 8, 1969—The COMSAT Laboratories at Clarksburg, Maryland, were completed and occupied by a staff of about 300 persons, half of them professional scientists and engineers. At the Laboratories, COMSAT is engaged in a broad range of research and development projects to advance the technology of satellite communications.



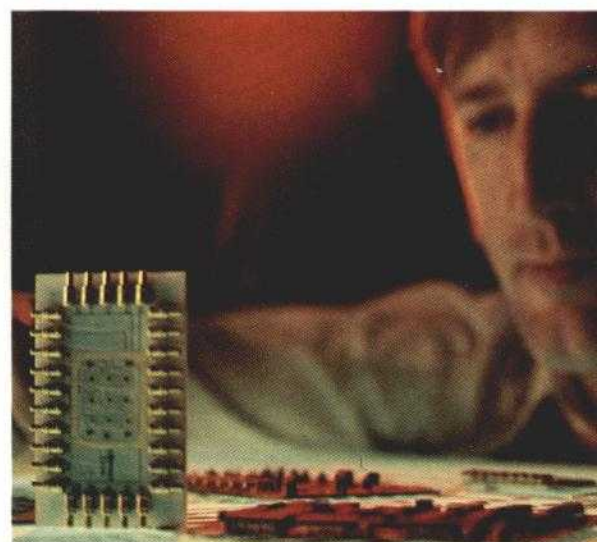
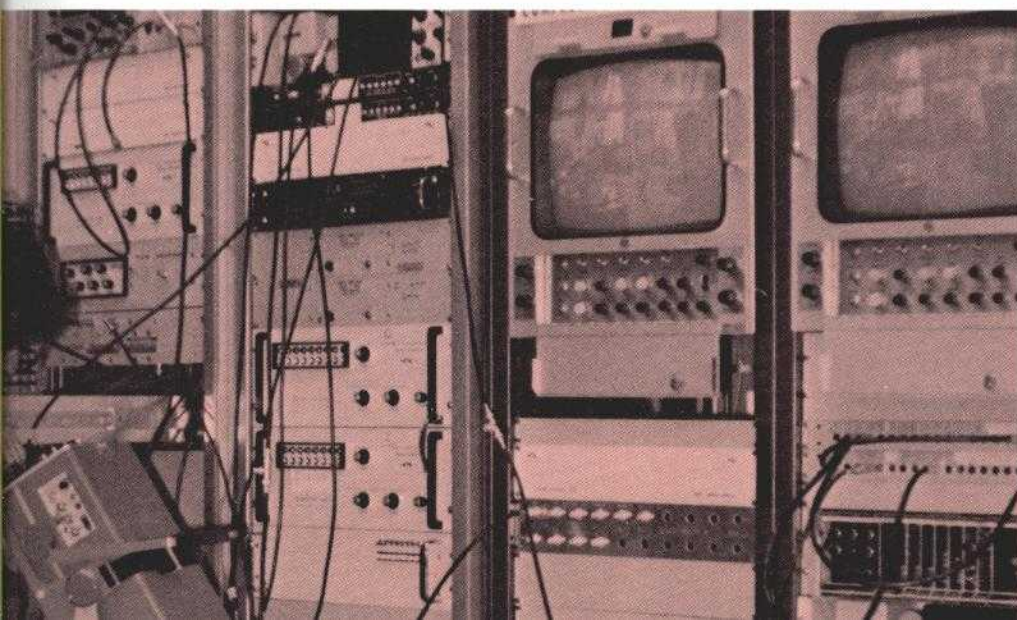
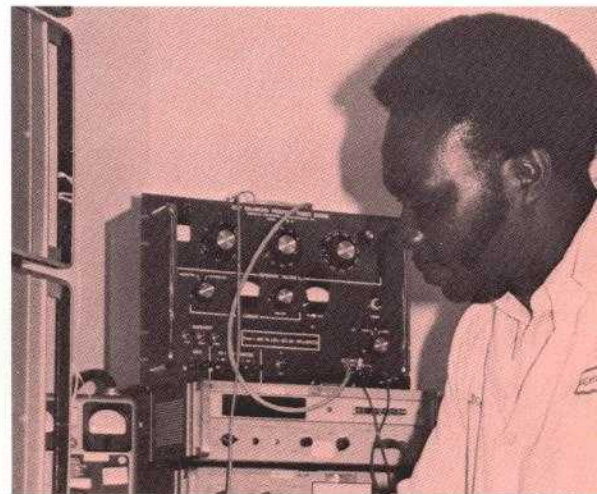
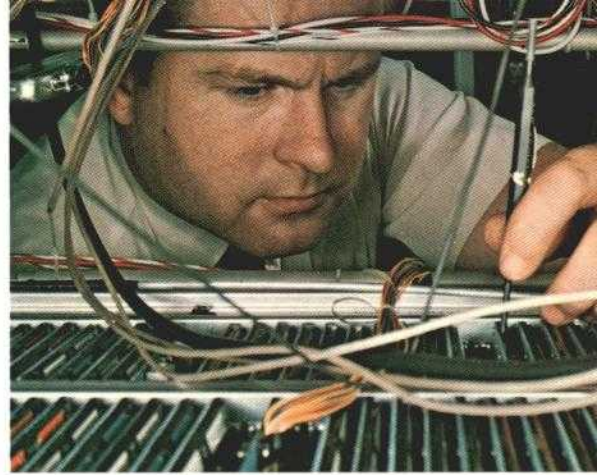

On July 20, 1969, from the Oval Office in the White House, I spoke by telephone with Neil Armstrong and Edwin Aldrin on the surface of the Moon. This historic event was simultaneously televised to the world through the medium of communications satellites . . . The Communications Satellite Act speaks of the contribution to be made to "world peace and understanding" by a commercial communications satellite system. Just as this technology has enabled men to speak to each other across the boundary of outer space, so, I am convinced, satellite communications will in future years help men to understand one another better across boundaries of political, linguistic and social nature. World peace and understanding are goals worthy of this new and exciting means of communication.

RICHARD NIXON
February 1970

1970

May 12, 1970—COMSAT again submitted a proposal for a satellite system to provide aeronautical communications service to the Federal Aviation Administration and the airline industry.

June 21, 1970—The World Cup soccer matches in Mexico City ended after three weeks of play during which the satellite system transmitted more than 500 half-channel hours to a worldwide audience. This service illustrated the worldwide demand for live coverage of major sports events, a demand which the satellite system is meeting with hundreds of TV transmissions a year.

July 1, 1970—Commercial service was begun at the new Bartlett Earth Station at Talkeetna, Alaska. The Bartlett station with a 98-foot antenna, is one of the fourth generation of earth stations. Each generation was characterized by better performance, wider bandwidth, lower cost, and simpler operation and maintenance.



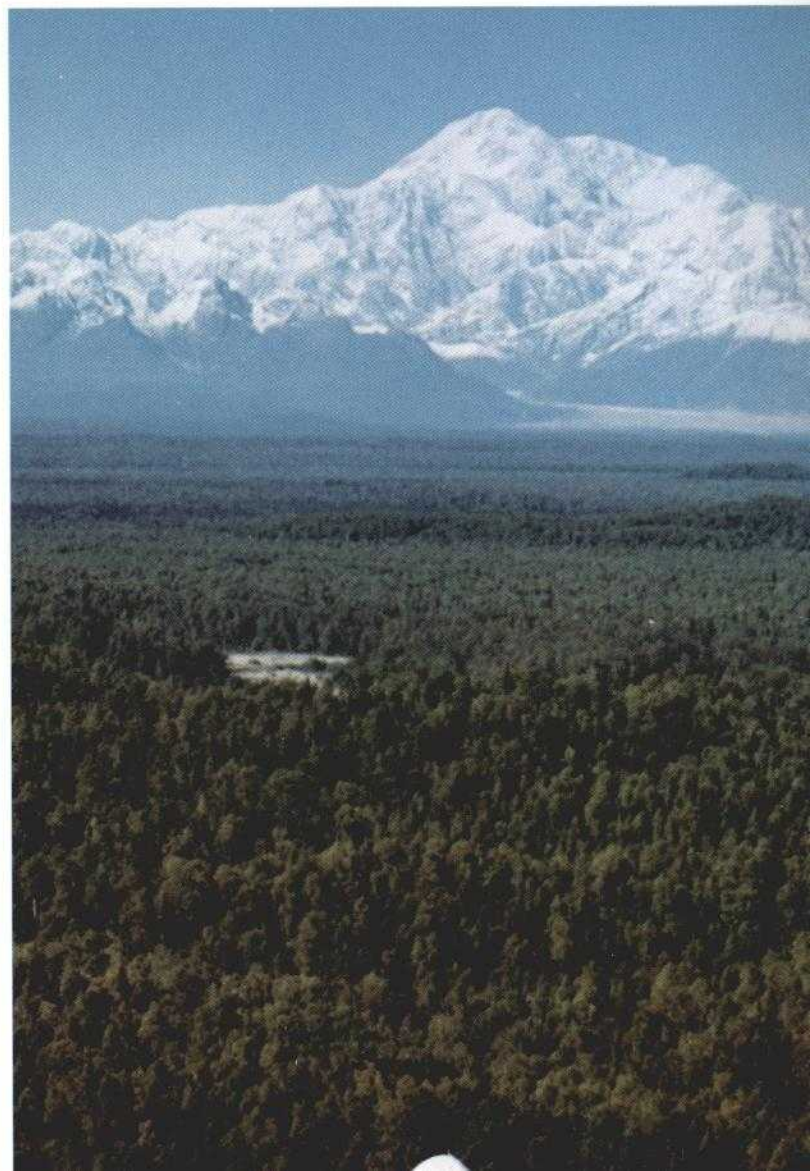
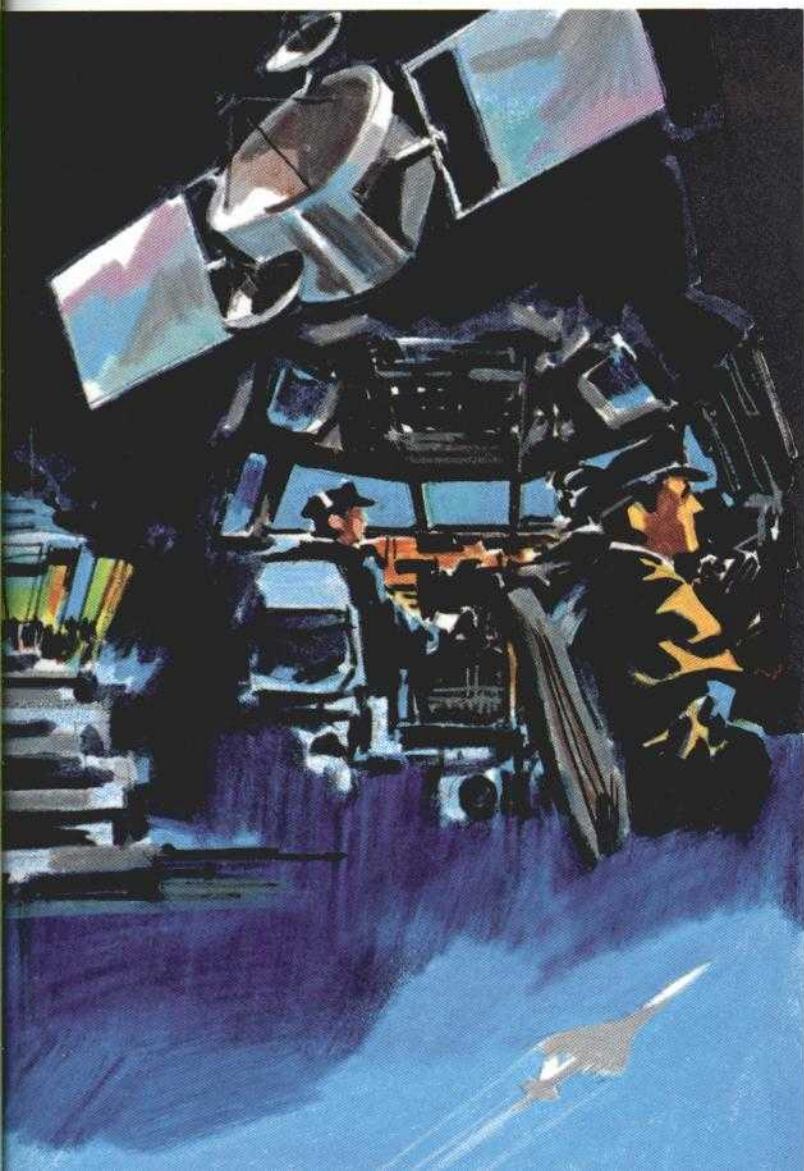
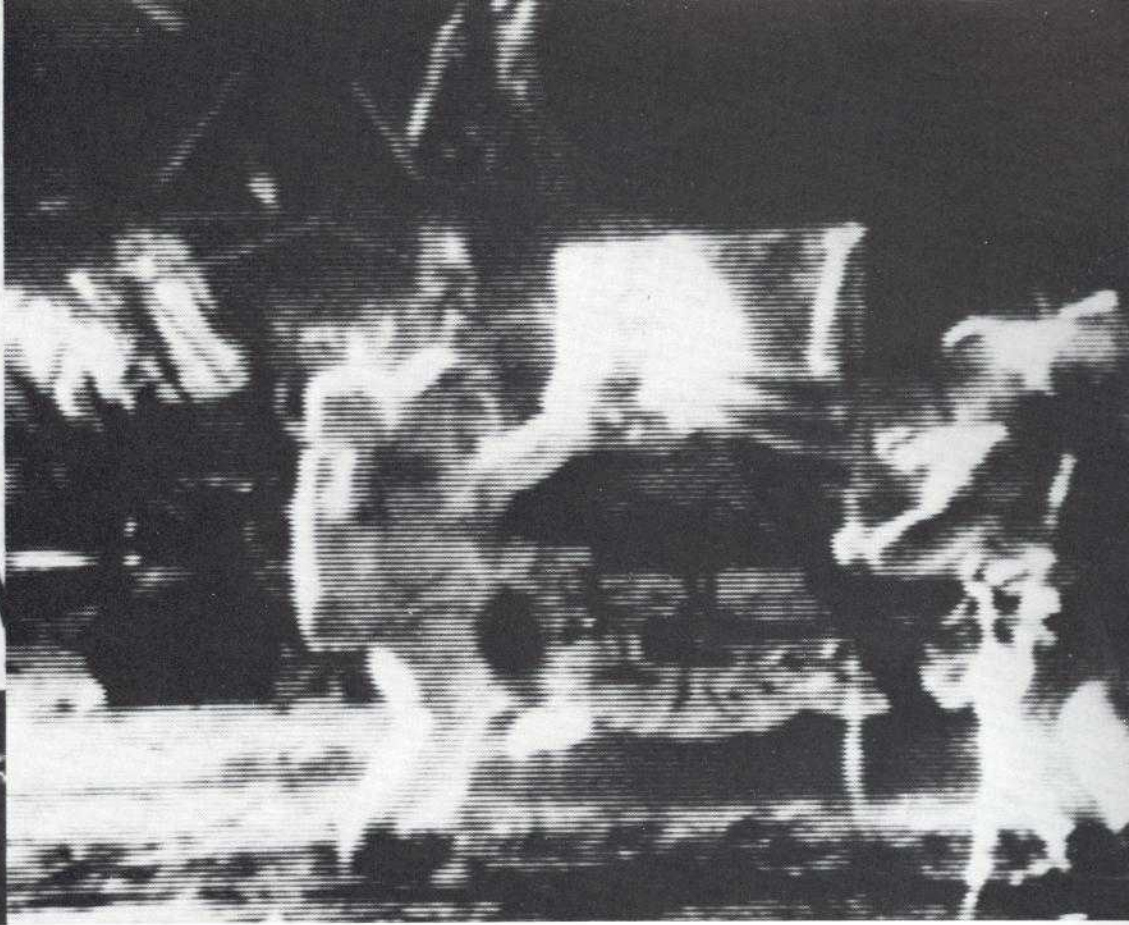
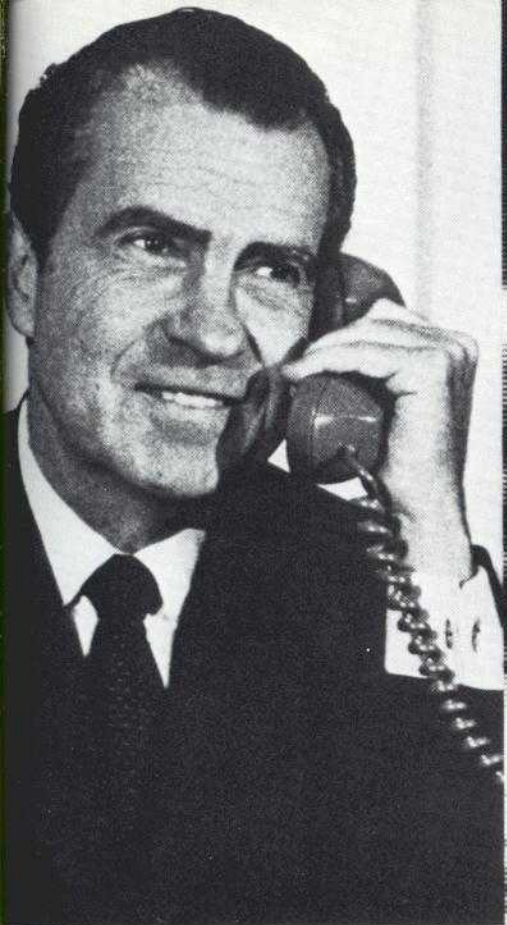



October 16, 1970—Increases in revenues, net operating income, and net income permitted the Board of Directors to declare COMSAT's first quarterly dividend of 12½ cents per share. In 1972 the quarterly rate was increased to 14 cents, the maximum increase allowable at that time under Federal guidelines on interest and dividends.

October 19, 1970—In another proposal to the FCC, COMSAT applied for authority to establish a domestic satellite system to provide leased capacity to American Telephone and Telegraph Company and followed, in 1971, with an application for a separate COMSAT multipurpose system to serve users other than AT&T.

COMSAT REVENUES



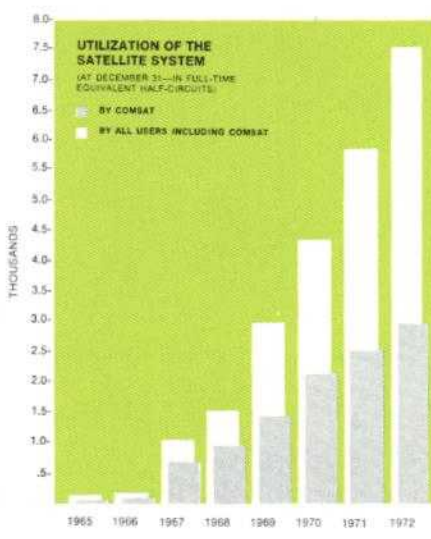
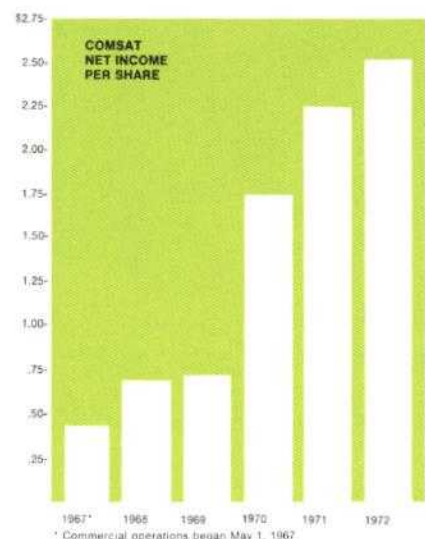
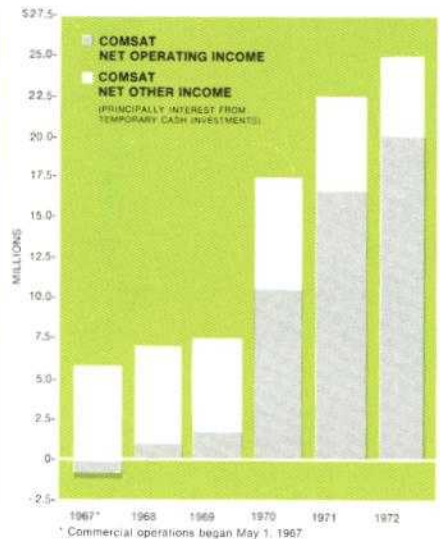
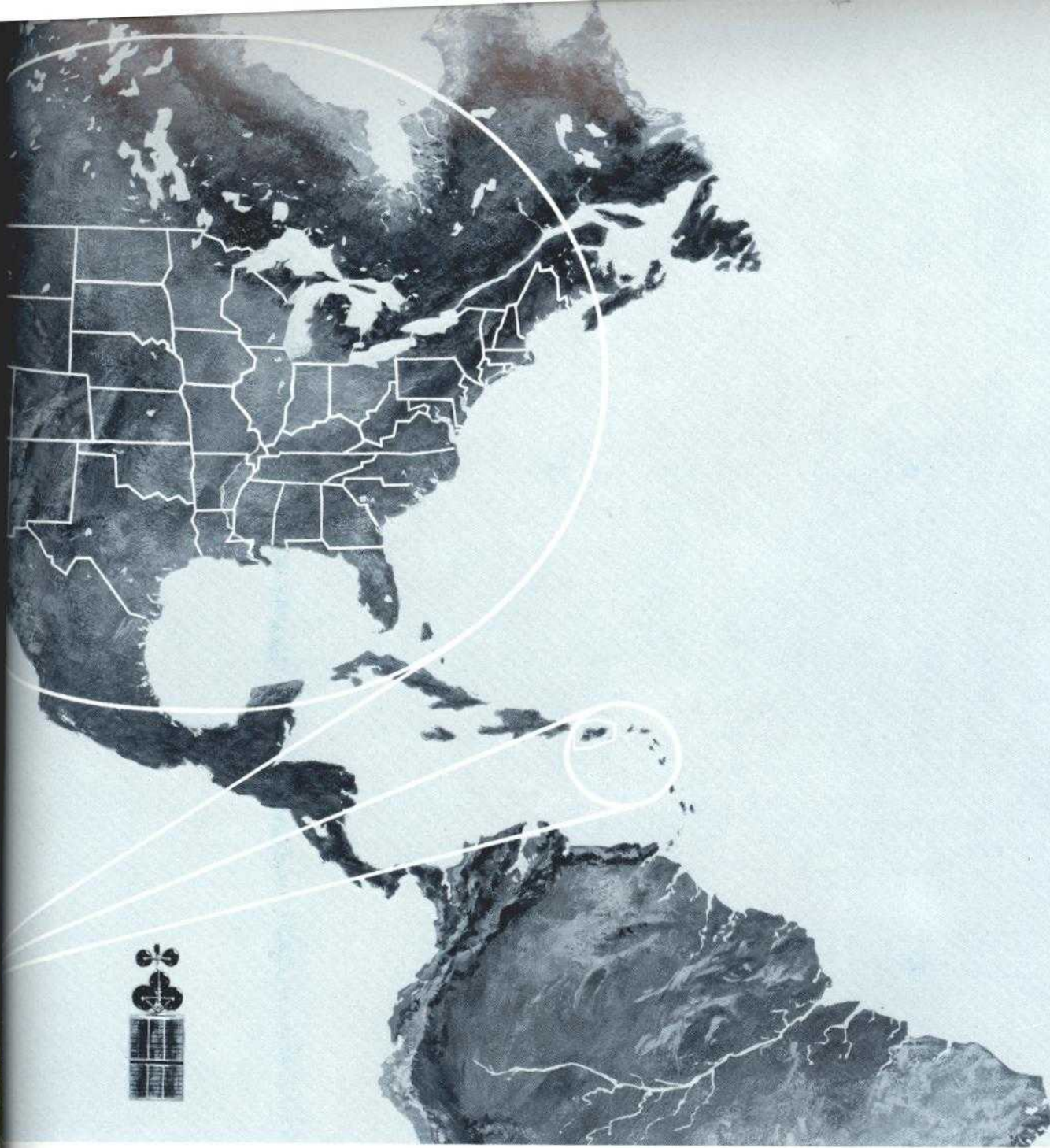

89
began May 1, 1967

* Commercial operations began May 1, 1967.

* Commercial operations began May 1, 1967.

THOUSANDS

January 25, 1971—Global satellite capability was greatly expanded with the first launch of an INTELSAT IV satellite, which was placed in service over the Atlantic Ocean on March 26.

In an average communications configuration, each of the IV's provides about 5,000 telephone circuits plus capacity for simultaneous television.

Like their predecessors in the INTELSAT system, the IV's are in synchronous equatorial orbit. The launch vehicle for the IV's is the Atlas-Centaur, a larger, higher-capacity vehicle than those of the Delta series used in all previous INTELSAT launches.

1971

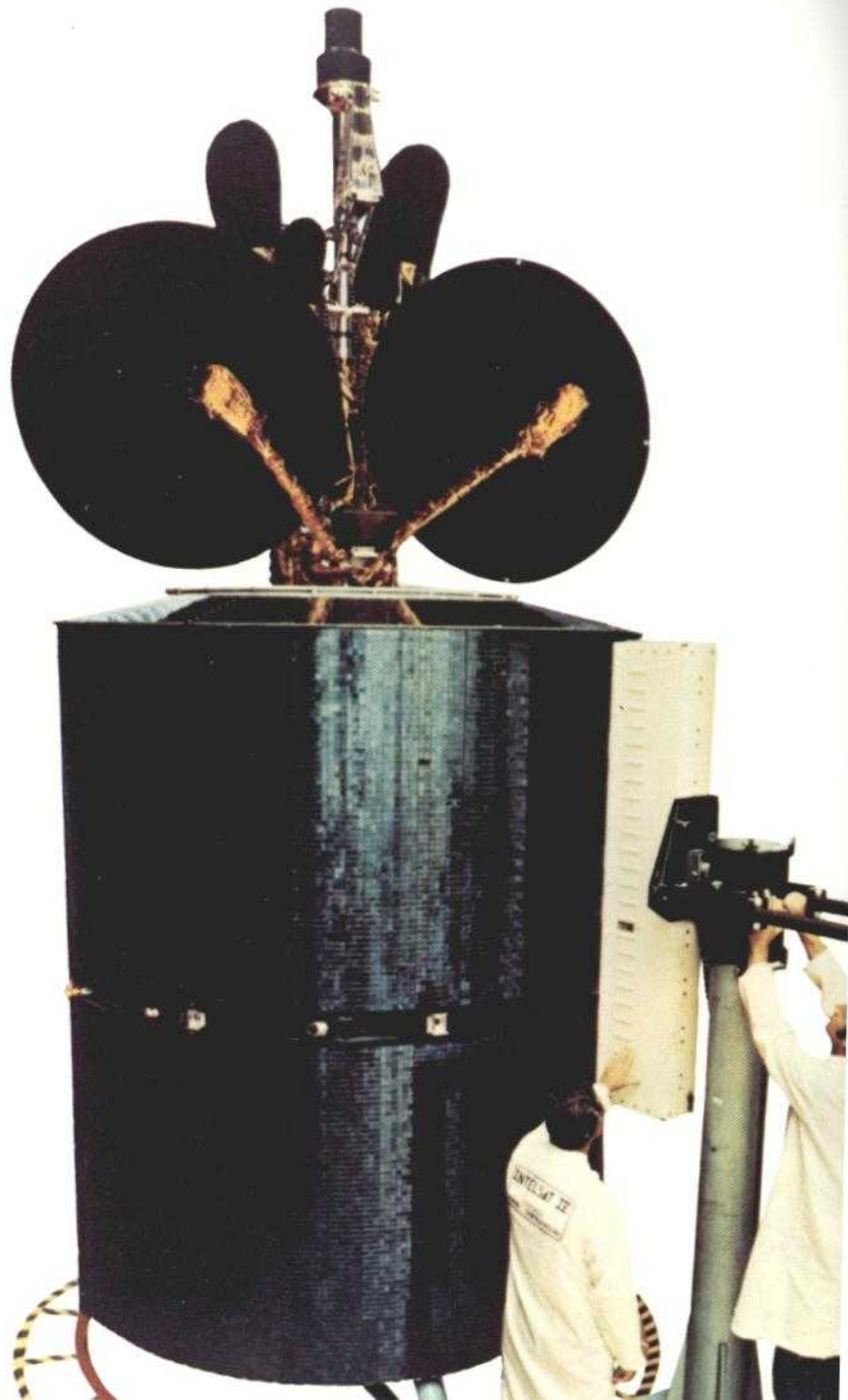



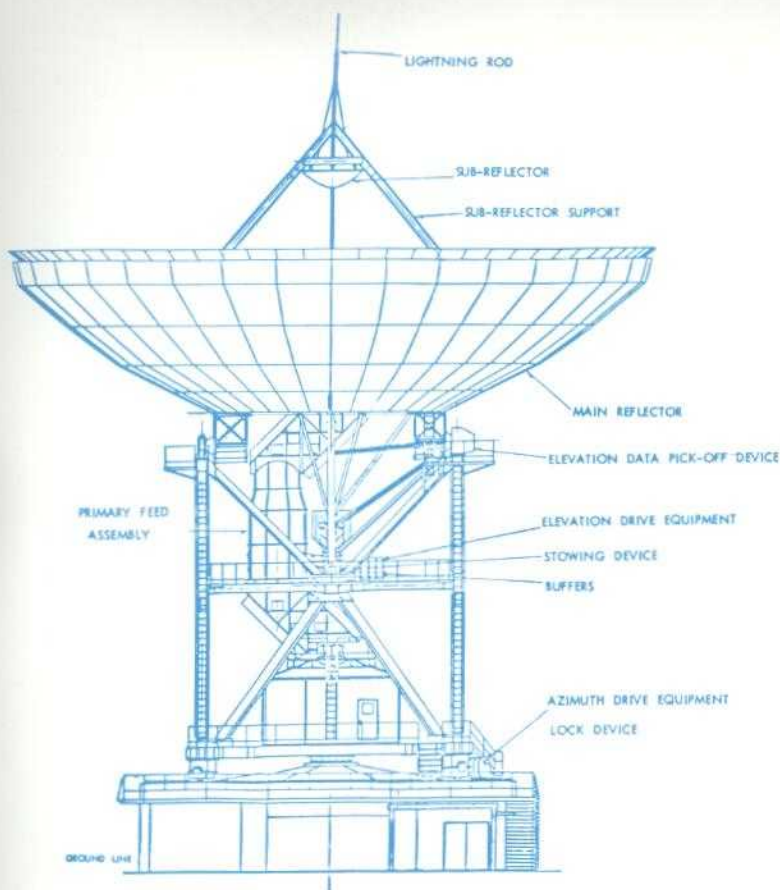

August 6, 1971—NICATELSAT, a joint venture of COMSAT and the Government of Nicaragua, was established to build and operate an earth station and to handle Nicaragua's overseas international communications. The standard earth station near Managua, Nicaragua, was completed at the end of 1972 and put into commercial service. COMSAT owns 49 percent of NICATELSAT and provides technical, training, and operational services under contract to NICATELSAT.

August 20, 1971—The agreements for definitive arrangements for INTELSAT were opened for signature. The U.S. was among the first to sign.

The arrangements entered into force 60 days after the agreement had been adhered to by two-thirds (54) of the 80 governments which were parties to the interim agreement as of August 20, 1971.

On behalf of the U.S., Joseph V. Charyk, COMSAT President, and William P. Rogers, Secretary of State, signed the definitive agreements at the Department of State.

Among the service highlights of 1971 was the dedication on December 3, 1971, of the Scandinavian earth station at Tanum, Sweden. The dedication included the first transatlantic picture telephone transmission. Via satellite two grandparents in Sweden saw their grandchild in the United States (at COMSAT for the occasion) for the first time. Dr. Joseph V. Charyk also spoke to dignitaries at the Scandinavian earth station via picturephone.

December 19, 1971—The second INTELSAT IV was launched successfully and placed in service over the Atlantic Ocean on February 19. This satellite and the first Atlantic IV provided a combined capacity of about 10,000 telephone circuits across the Atlantic. They replaced the INTELSAT III satellites in that region.

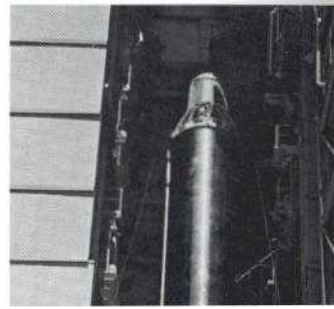



1972

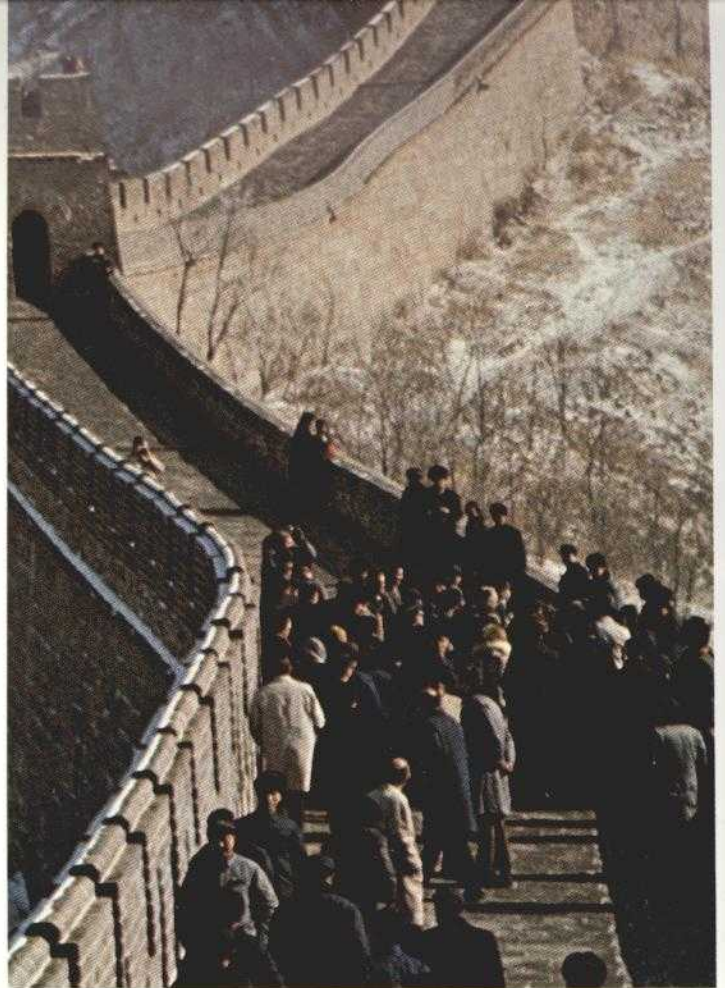

In the relatively short span of seven years, communication by satellite has changed the world forever. We now live, in one very real sense, much closer to other peoples and to faraway events. The fast-developing science of satellite communications must rate as one of the true marvels of the 20th century—a technological triumph that is bringing greater understanding to a world badly in need of closer ties and deeper insights . . . I am certain that the Congress will share my fascination and satisfaction with the speed in which participation in satellite communications is spreading across the world as a new and constructive force among nations and peoples.

RICHARD NIXON
April 1972

February 20, 1972—President Richard Nixon arrived in Peking for his historic visit to the People's Republic of China. The satellite communications coverage of the President's visit included television, news photo, and news dispatch transmissions. These were transmitted from temporary antennas installed in Peking and Shanghai to an INTELSAT IV satellite over the Pacific Ocean and thence to the Jamesburg, California, Earth Station for distribution in the United States and relay to other countries.



January 15, 1972—A new standard antenna went into service at the Andover, Maine, Earth Station, replacing the 10-year-old radome-covered horn antenna that had been built for Telstar experiments and later modified for commercial service. Similar second antennas were planned for Andover and Etam, West Virginia, to increase capability for U.S. transatlantic satellite communications.

January 22, 1972—The third launch in the INTELSAT IV series resulted in the emplacement of one of these advanced, high-capacity satellites over the Pacific Ocean.

May 15, 1972—COMSAT and the Cunard Line completed a two-month experiment which successfully demonstrated satellite communications between ship and shore. COMSAT installed a small antenna and associated equipment on the top deck of the liner Queen Elizabeth 2. Through an INTELSAT IV satellite over the Atlantic Ocean, voice and data communications were transmitted between the Queen Elizabeth 2 at sea and the COMSAT Laboratories at Clarksburg, Maryland.

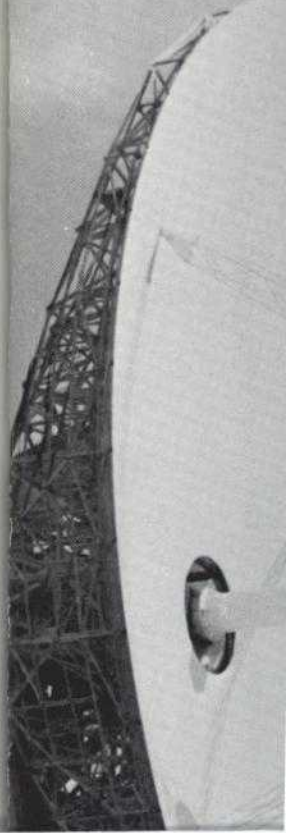

May 22, 1972—President Richard Nixon arrived in Moscow for the first visit by an American President to the Soviet Union. As it did during the President's visit to China, the satellite system transmitted television coverage of the visit to a worldwide audience.

On the China visit, the TV programming entered the satellite system via transportable antennas almost at the point of origin. On the U.S.S.R. visit, the programming was relayed almost 2,000 miles via terrestrial facilities to the West German earth station at Raisting before entering the satellite system.

COMPONENT ARRANGEMENT OF INTELSAT IV

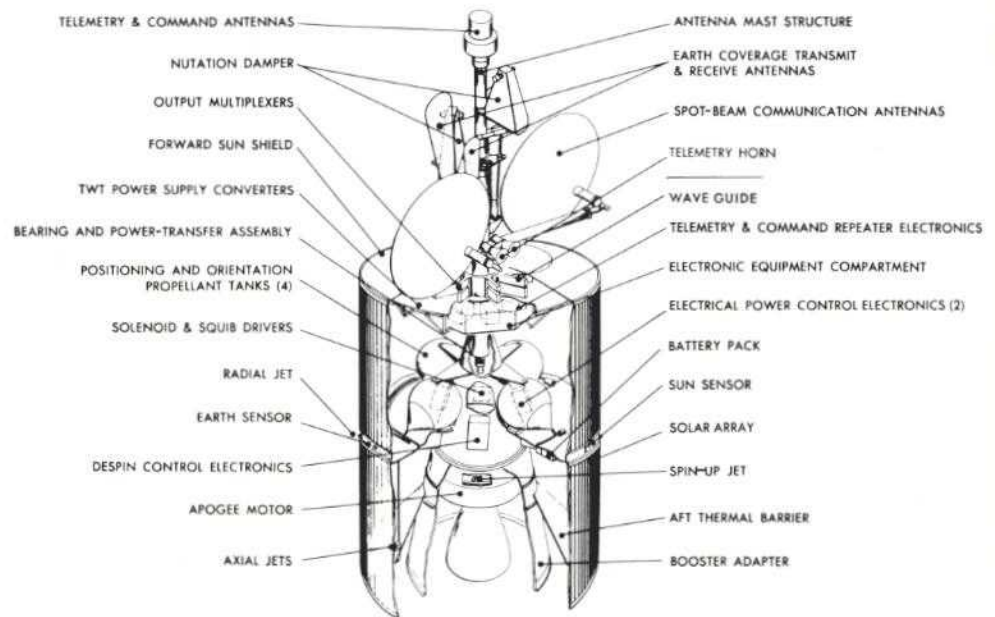

June 13, 1972—The fourth launch in the INTELSAT IV series was successful, just as the first three had been. The satellite was placed in service over the Indian Ocean, completing global coverage by the

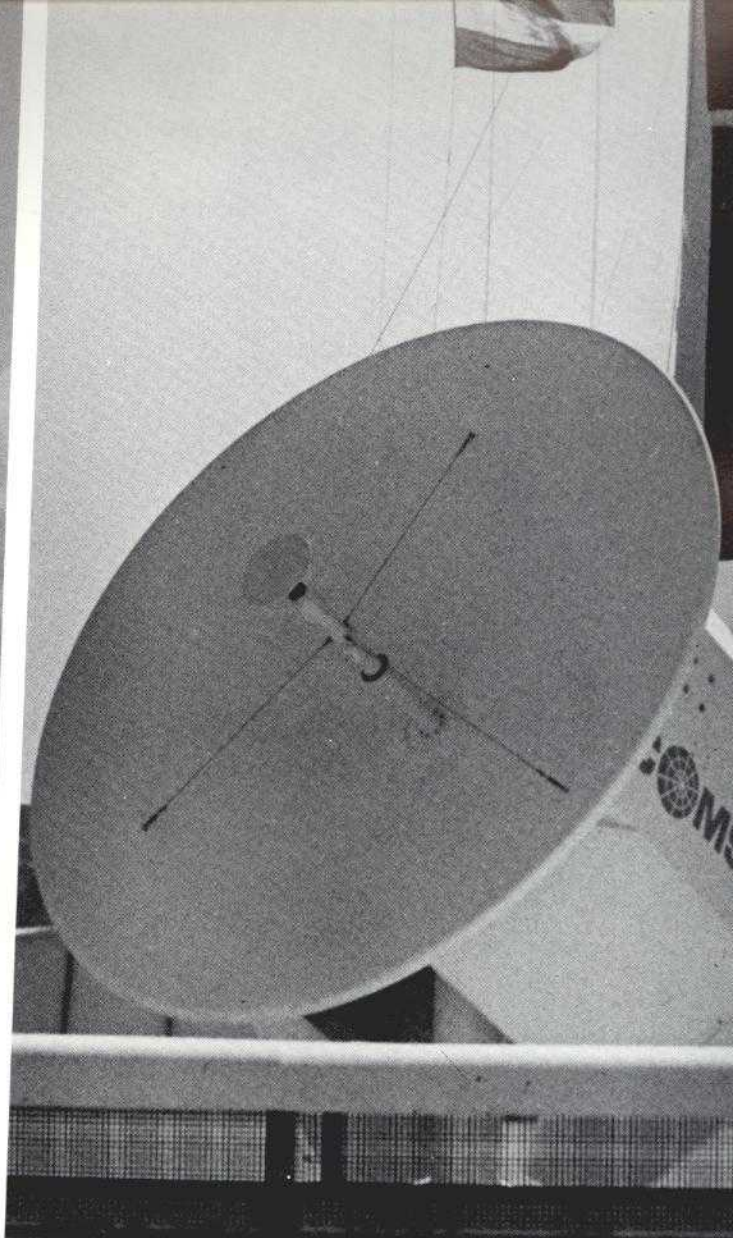
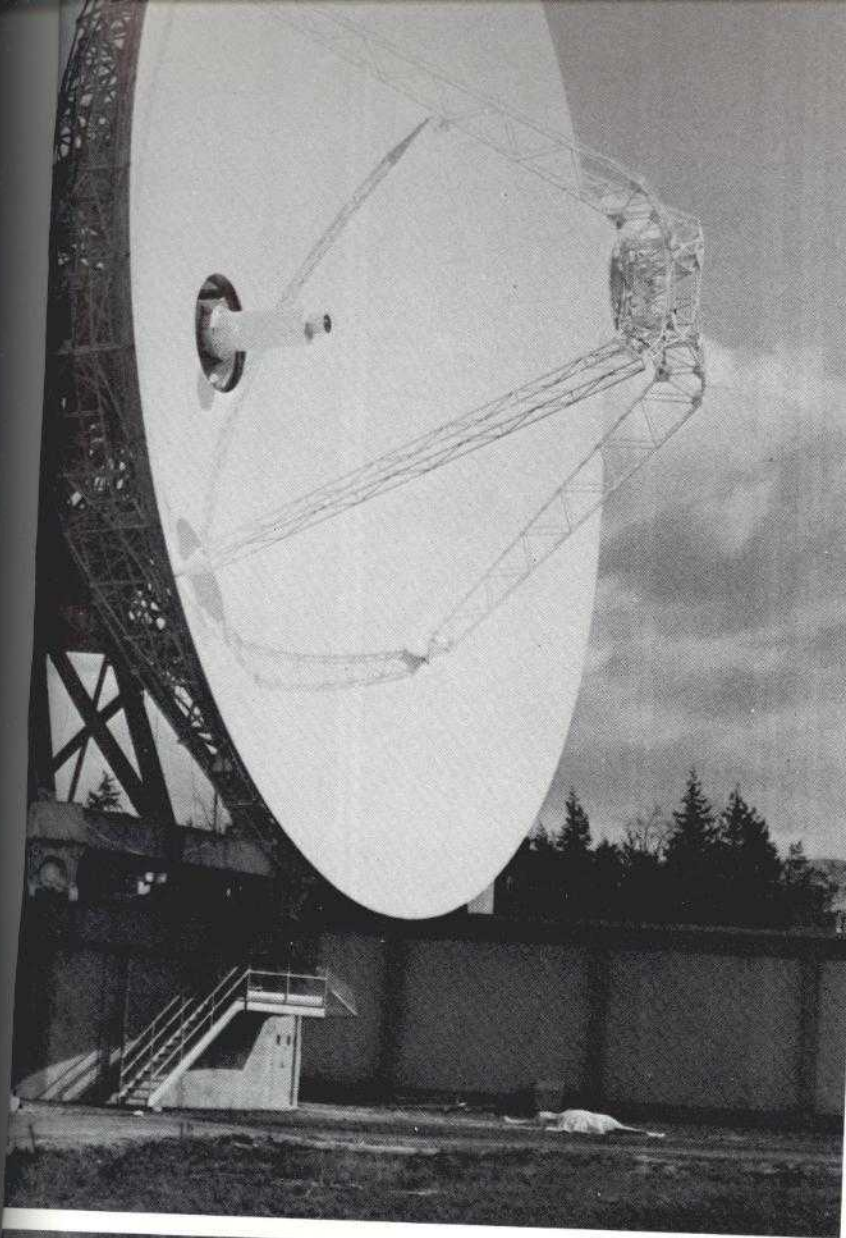

In conjunction with the satellite communications service during President Nixon's visit to China, COMSAT sponsored its first mass-media advertising. A 30-second TV commercial was seen in major U.S. cities and a series of full-page newspaper advertisements were published in major cities. The adver-

tising in U.S. media emphasized that "If it's via satellite, it's via COMSAT."

At the bottom of this page are black and white illustrations of the covers of COMSAT Annual Reports to Shareholders.

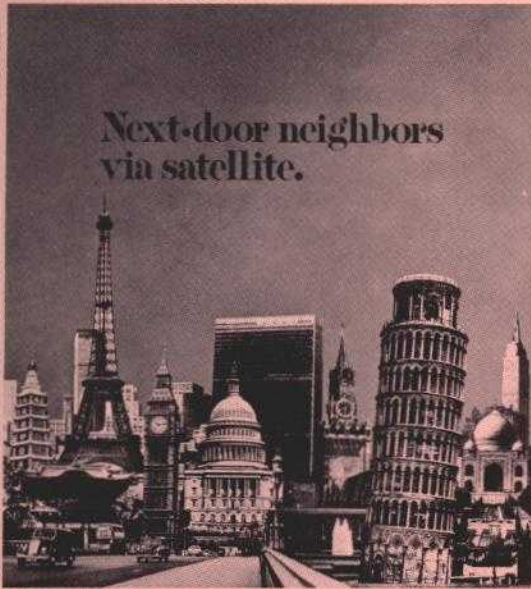

Next-door neighbors via satellite.

... making it possible for us to live together in a world that is really so big.

COMSAT is helping pull the world together... putting the same plans on the main street of business, industry and com-

munication... giving people a new way to live via satellite... planning new potentials for U.S. citizens, as well as international telephone, television, telegraph, data and facsimile communications.

COMSAT, a shareholder-

owned communications company created by the Communications Satellite Act of 1962 operates the satellites in the global system... U.S. earth stations for satellite communications... the COMSAT Laboratories and a wide range of related technical

activities that are creating new communications systems.

These are a part of a worldwide satellite system to give you better communications.

More than 90 countries already communicate daily with each other via satellite.

COMSAT AT 10

COMMUNICATIONS SATELLITE CORPORATION - 1000 EAST PLAZA, S.W. - WASHINGTON, D.C. 20024



Your front row seat via satellite

Important things are going on in the world.

Once you had to wait for news film. Now you can see what's going on... via satellite... through the magic window of your TV screen.

COMSAT, a shareholder-owned communications company, operates the satellites in the global system... the U.S. earth stations for satellite communications... the COMSAT Laboratories and related technical activities that are creating new communications advances.

These operations are all part

of a worldwide satellite system reaching into more than 80 countries... pioneering new potentials for domestic as well as international telephone, television, telegraph, data and facsimile communications.

In the United States, if it's via satellite, it's via COMSAT.

Write to COMSAT's Information Office for the booklet, "Via Satellite. The COMSAT Story."

COMSAT

COMMUNICATIONS SATELLITE CORPORATION
1000 E. PLAZA, S.W., WASHINGTON, D.C. 20024

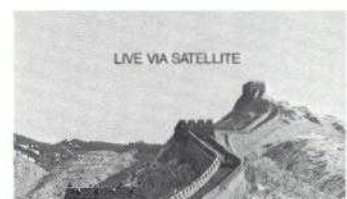
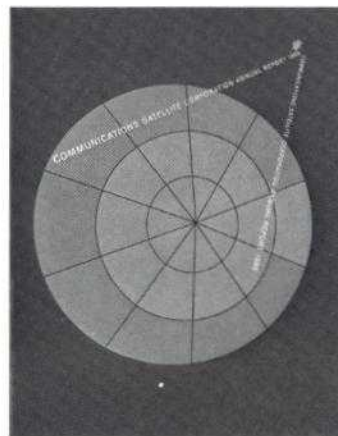
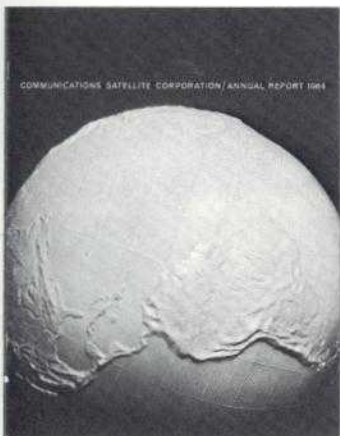

March 1, 1972—Hearings began in the COMSAT rate case before the Federal Communications Commission, following the submission of voluminous COMSAT testimony. About a dozen COMSAT witnesses appeared in the following months. The activation of the rate case by the FCC was further evidence that COMSAT was maturing. The principal issues include a reasonable rate of return and an appropriate rate base for COMSAT.

August 31, 1972—At the 10th anniversary of the signing of the Satellite Act by President John F. Kennedy, COMSAT sponsored full-page newspaper advertisements, calling attention to the accomplishments to date in fulfilling the national objectives set forth in the Act. COMSAT also timed its Annual Report to the President of the United States and the Congress to coincide with the anniversary.

September 8, 1972—COMSAT made a new proposal for U.S. domestic services as the Federal Communications Commission proceeding for the authorization of domestic systems continued. COMSAT requested the FCC to authorize COMSAT's participation in two domestic systems—(1) COMSAT's earlier proposal for a system of satellites for lease to American Telephone and Telegraph Company, and (2) a multipurpose system for nationwide services to be jointly owned by COMSAT, Lockheed Aircraft Corporation, and MCI Communications Corporation.

September 10, 1972—Satellite television coverage of the 20th Olympic Games in Munich, Germany, in late August and early September set a record for such coverage of a special event. All four INTELSAT IV satellites were used in transmitting 1,023 half-channel hours of TV coverage to earth stations in 33 countries. The countries ordering the greatest volume of coverage were Mexico, the United States, and Iran, in that order.

December 12, 1972—With ratification by Jamaica, the number of nations approving the INTELSAT definitive arrangements increased to 54. This was the number necessary for the arrangements to come into force, which they did on February 12, 1973. The definitive arrangements supersede the interim arrangements under which INTELSAT has operated since its beginning.

December 22, 1972—In a major policy decision, the FCC approved COMSAT's proposed domestic satellite systems—a system of COMSAT satellites for lease to American Telephone and Telegraph Company and a separate, multipurpose domestic satellite system to be established through a joint

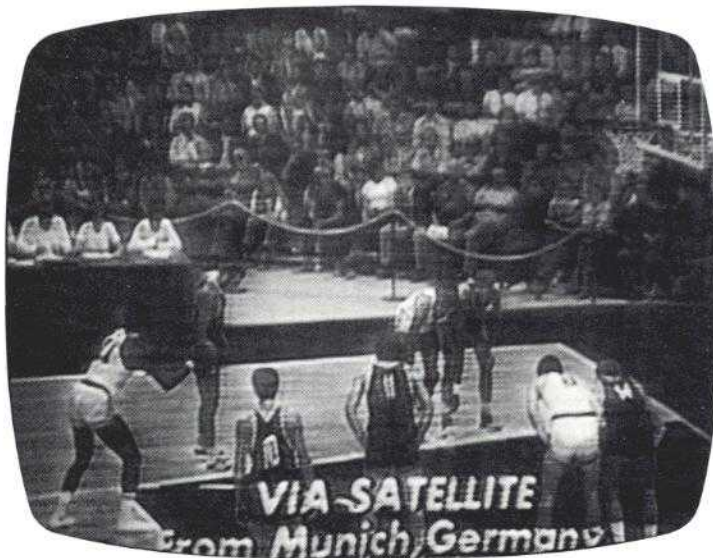
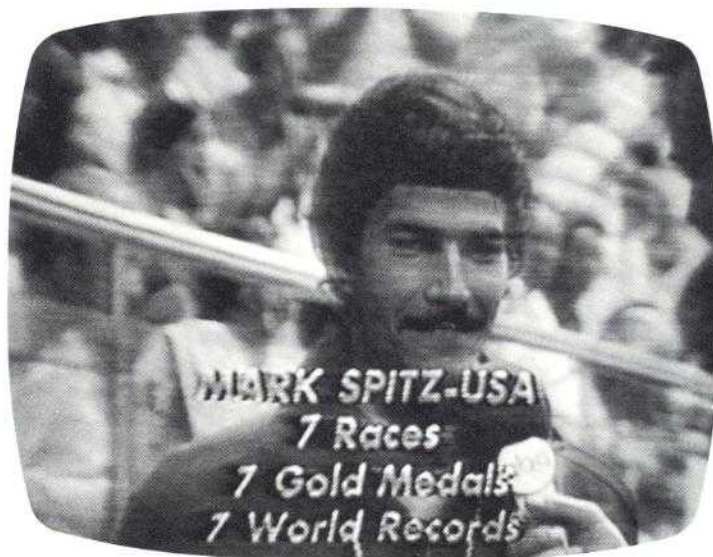



Brewster, Washington



Buitrago, Spain



Camatagua, Venezuela



Carnarvon, Australia



Cayey, Puerto Rico



Emeq Ha'ela, Israel

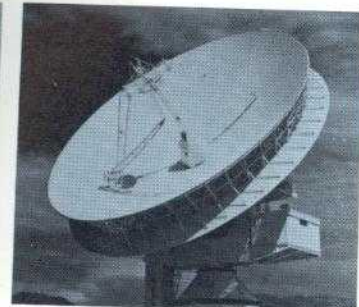

Fucino, Italy

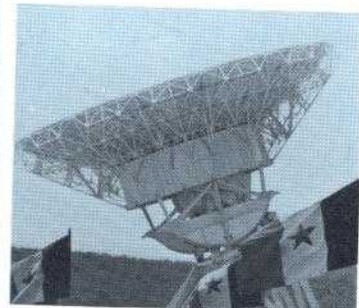

Gandoul, Senegal

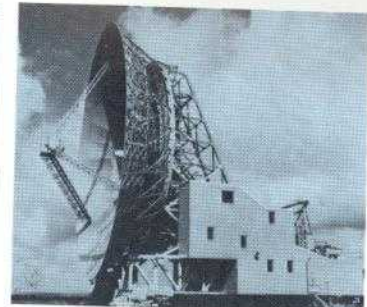

Goonhilly Downs, England



Hong Kong



Lanlate, Nigeria



Lessive, Belgium



Longonot, Kenya (East Africa)



Longovilo, Chile



Lurin, Peru



Isele, Zaire



Paumalu, Hawaii

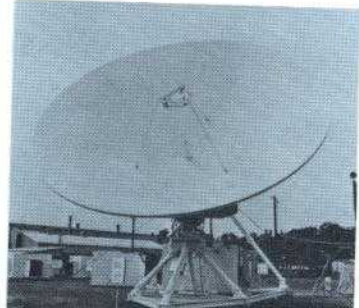

Peking, China

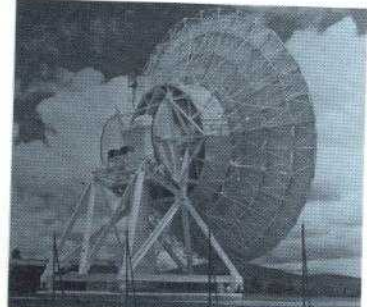

Philibert Tsiranana, Malagasy



Pleumeur-Bodou, France



Sables, Morocco



Sentosa, Singapore

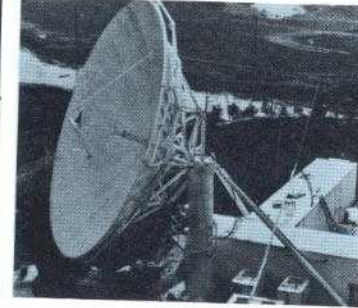

Shanghai, China

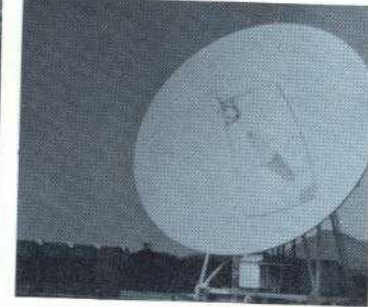

Si Racha, Thailand



Taipei, China



Cancino, Mexico



Umm Al-Aish, Kuwait



Utibe, Panama



Vikram, India



Warkworth, New Zealand



Malaysia



Choconta, Colombia



Deh Mandro, Pakistan



Djatuluhur, Indonesia

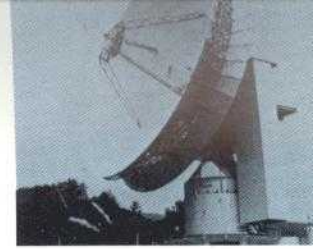

Etam, West Virginia



Guatemala

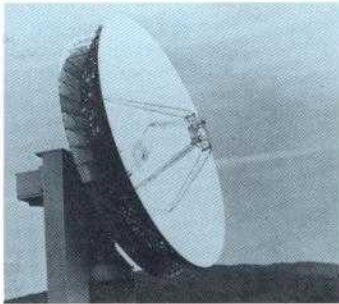

Jamesburg, California



Kuantan, Malaysia



Kum San, Korea



Lake Cowichan, Canada

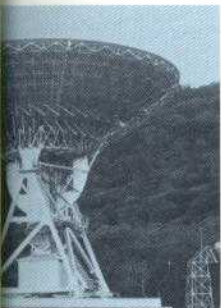

Guatemala

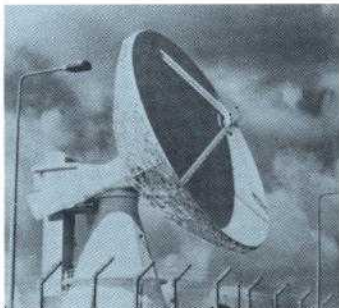

Matura Point, Trinidad & Tobago



McMurdo Sound, Antarctica (data transmission only)



Mill Village, Canada



Moree, Australia



Jamaica



Pulantat, Guam



Quito, Ecuador

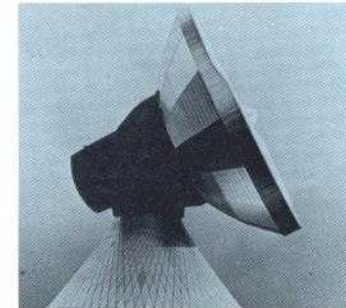

Raisting, Germany



Ras Abu Jarjur, Bahrain



Guatemala



Tangua, Brazil



Tanum, Sweden



Thermopylae, Greece

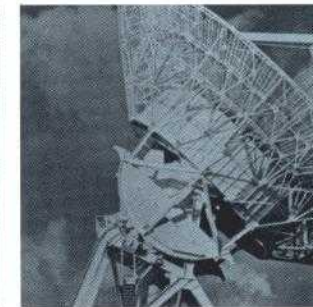

Trois-Ilets, Martinique



Guatemala

An expanding global network of earth stations provides high-quality satellite communications services directly to 49 countries and indirectly to more than 30 other countries.



Joseph H. McConnell
Chairman of the Board, Communications Satellite Corporation, and director, Reynolds Metals Company, Richmond, Va. (Series I)



Philip W. Buchen
Partner, Law, Buchen, Weathers, Richardson & Dutcher (Attorneys), Grand Rapids, Mich. (Series I)



Joseph V. Charyk
President, Communications Satellite Corporation, Washington, D. C. (Series I)



James E. Dingman
Director of a number of companies and former Vice Chairman of the Board, American Telephone and Telegraph Company, New York, N.Y. (Series II)



Frederic G. Donner
Chairman of the Board of Trustees, Alfred P. Sloan Foundation, and a director of General Motors Corporation, New York, N.Y. (Presidential Appointee)



Gordon Edwards
Director of a number of companies including Kraftco Corporation, New York, N.Y. (Series I)



William W. Hagerty
President, Drexel University, Philadelphia, Pa. (Series I)



Richard R. Hough
A Vice President, and President of the Long Lines Department, American Telephone and Telegraph Company, New York, N.Y. (Series II)



George L. Killion
Director of a number of companies, including American President Lines, Ltd., San Francisco, Calif. (Series I)

Comsat Directors

From the 1972 Annual Report to Shareholders

** On May 18, 1972, the President of the United States appointed Mr. Frank E. Fitzsimmons to succeed Mr. Meany, who had informed the President that he wished not to be reappointed. As of the date of this report, Mr. Fitzsimmons' appointment was awaiting confirmation by the U.S. Senate.*



James McCormack
Former Chairman and Chief Executive Officer, Communications Satellite Corporation, and director of a number of companies, Washington, D.C. (Series I)



George Meany*
President, AFL-CIO, Washington, D.C. (Presidential Appointee)



Horace P. Moulton
Attorney and former Vice President and General Counsel, American Telephone and Telegraph Company, New York, N.Y. (Series II)



Rudolph A. Peterson
Administrator of the United Nations Development Programme and Chairman of the Executive Committee and a director, Bank of America N.T. & S.A., New York, N.Y. (Series I)



Bruce G. Sundlun
Partner, Sundlun, Tirana & Scher (Attorneys), Washington, D.C., and Providence, R. I., and President and a director, Executive Intelligence Review, Washington, D.C. (Series I)



Leo D. Welch
Former Chairman and Chief Executive Officer, Communications Satellite Corporation, and director of a number of companies, Washington, D.C. (Series I)

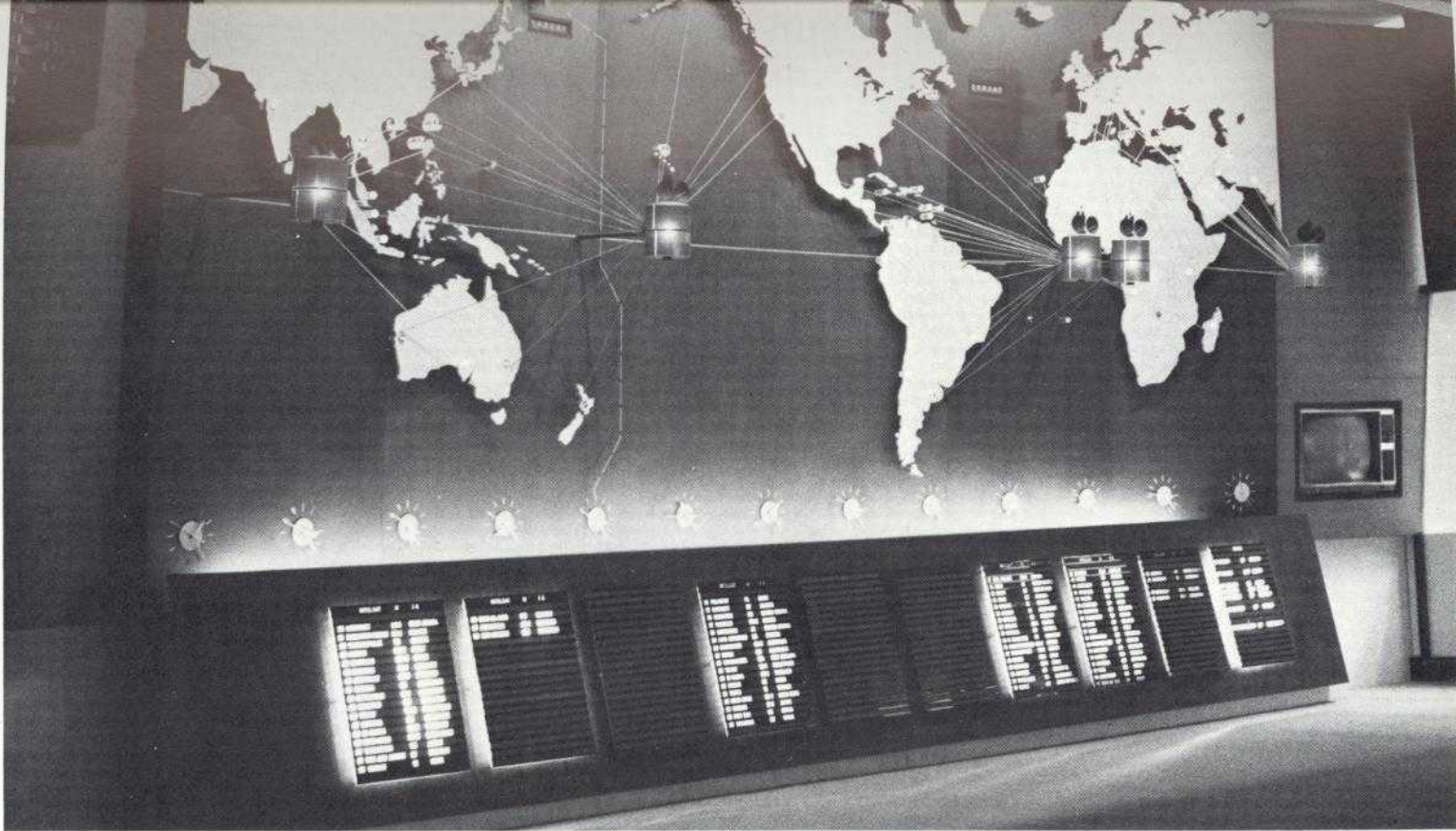

At the Operations Center in COMSAT headquarters, operational satellites are displayed on the global system status board.

PRESENT

February 1, 1973—By the 10th anniversary of its incorporation, COMSAT had accumulated extensive experience in the operation of a commercial satellite system. It remains the only company with such experience. COMSAT also has the largest investment in the global system of satellites and earth stations. For 7½ years since Early Bird, COMSAT has managed the satellite system on behalf of all the owners.

By February 1, 1973, the global satellite system had become a remarkable success, providing about half of the world's international telephone communications and growing volumes of record traffic and television.

At the time of Early Bird, there were only five earth stations for commercial satellite communications; only two of these could operate with Early Bird at any one time. By February 1, 1973, the global earth station network comprised 80 antennas at 65 earth stations in 49 nations. These provided 251 full-time communications pathways through the

four INTELSAT IV satellites in full-time service.

Additional INTELSAT IV launches are planned for 1973 and 1974. Development of an even more advanced series of satellites, INTELSAT IV-A, is under way for implementation in 1975.

Additional earth stations and antennas are being developed. About 13 more antennas are expected to go into operation in 1973. By the end of 1975, earth station facilities are expected to total 113 antennas at 86 earth stations in 65 countries. The satellite system has vastly improved the world's communications network in a short period of time. Utilization of the global system has grown steadily.

For COMSAT the first 10 years have been years of progress. The global system has been firmly established, and further advances in satellite communications are under way.